

WHERE MAGIC HAPPENS...



PATIO COVERS

CARPORTS

FAÇADE ELEMENTS

GARDEN ELEMENTS

ENJOY MORE OF YOUR OUTDOOR SPACE IN STYLE

A garden is there to be enjoyed in the fullest. So it's best to spend as much time in it as possible. Whether it's barbecuing with friends, enjoying the sun, or enjoying some me-time or time with your family in the peace and quiet, we rejuvenate when we can spend more time outside to experience those great moments.

But you'll also want to continue that same beautiful unique style around the rest of the outdoor space... because appearances do count for something. 1 design, 1 uniform use of colour, 1 style from the front garden to the back garden... That's the idea; and produced by 1 manufacturer in 1 go, in the same exact colour, with the same materials, and the same quality guaranteed.

Even if you have your outdoor space constructed in phases. Thanks to the Renson Outdoor Concept, you can enjoy your outdoor space more.

The possibilities to protect yourself from the wind, sun, rain, or cold are numerous and the expansion and personalization possibilities are varied. Your garden or terrace, and the rest of the environment around your home, become a natural extension of your home so that you can spend time outside in and in the greatest comfort.

Renson's outdoor products provide that extra living space, completely adapted to your own style and based on your own wishes. A place for the children to play outside, an intimate space where you can enjoy a book and some alone time, that cosy outdoor space to have a drink with friends and family, and so much more. But also the perfect storage room, parking place for your car, screening from your neighbours, decoration and lighting for your front and back garden, and more.

There is a beautiful outdoor decor with Renson's various outdoor products for every style of home. There is a beautiful outdoor decor with Renson's various outdoor products for every style of home; an excellent addition to your home.

INTRO	5	
COMPLETE CONCEPTS	6	
PATIO COVERS	25	
CAMARGUE® LINE	29	
ALGARVE® LINE	57	
ELLICE	73	
AERO® LINE	77	
LAGUNE®	89	
LAPURE®	97	
APPLICATIONS FOR APARTMENTS	104	
CUSTOMISATION	109	
FAQ	135	
RANGE	146	
CARPORTS	149	
ALGARVE® CANVAS	153	
FAÇADE ELEMENTS	157	
LINARTE®	166	
LINIUS®	172	
LOGGIA® SLIDING PANELS	176	
GARDEN ELEMENTS	181	
LIGHTING - LINARTE OUTDOOR LIGHT	185	
SEATING & PLANTER UNIT - LINARTE MODULO	186	
FREESTANDING WALL - LINARTE ICON	188	
PARCEL LETTER BOXES - FENIX TOP	190	
WARRANTY & MAINTENANCE	192	



Algarve® & Algarve® Canvas

WHY CHOOSE RENSON OUTDOOR?



Superior quality and durability

Renson® is a European trendsetter in the field of natural ventilation, sun protection and outdoor products. Our high-quality products are manufactured in-house using our ultra-modern production facilities. We put our products through their paces in the most extreme situations to ensure the end result is flawless.

This testing process means our customers can be rest assured they're investing in the highest quality. With our network of well-trained Ambassadors, we can guarantee a faultless installation and service experience. Our professional approach extends to every aspect of our business.



Minimalist design

Our products are highly innovative in both their look and design. Seamless integration of optional elements, hidden fixings and fasteners, durable materials and smart solutions combined into a perfectly finished product that can be integrated into every type of home.



Endless personalization possibilities

We can offer you the perfect custom solution with our modular product design and countless integrated options. Custom screens, a wide choice of colours, sliding panels in various designs, glass walls, heating and music are just a few of the options that allow you to create a unique personal solution.



Ultimate ease of use and maintenance

Our products are designed to retain their quality and ease of operation for many years, in all types of weather. To ensure you can enjoy our products every day with as little maintenance as possible, we use materials of the highest quality that are guaranteed to last.



- ① Linarte® façade element with LED lighting – p. 166
- ② Linarte® ICON freestanding wall with LED lighting – p. 188
- ③ Linarte® ICON freestanding wall with wood inserts – p. 188
- ④ eSafe® parcel letter box – p. 190
- ⑤ Loggiawood® Linea sliding panels – p. 178
- ⑥ Linarte® façade element and gate – p. 166
- ⑦ Linarte® Outdoor Light S – p. 185

- ① Aero® Canvas roof element – p. 87
- ② Linarte® façade element with LED lighting and wood inserts – p. 166
- ③ Aero® Canvas roof element – p. 87
- ④ Linarte® Modulo 55 PLANT – p. 186
- ⑤ Linarte® Modulo 97 SIT – p. 186
- ⑥ Linarte® Outdoor Light M – p. 185



- ① Camargue® patio cover – p. 29
- ② Linarte® façade element – p. 166
- ③ Linarte® façade element with LED lighting – p. 166
- ④ Linarte® Modulo 97 SIT – p. 186
- ⑤ Linarte® Outdoor Light M – p. 185



- ① Camargue® patio cover – p. 29
- ② Linius® wall – p. 122
- ③ Camargue® patio cover – p. 29
- ④ Linius® façade element and gate – p. 172
- ⑤ Linarte® Outdoor Light S – p. 185



- ① Lapure® patio cover – p. 97
- ② Linarte® Modulo combination SIT & PLANT – p. 186
- ③ Linarte® Outdoor Light S – p. 185
- ④ Algarve® Canvas Classic Line carport – p. 153
- ⑤ Linarte® Modulo combination PLANT – p. 186
- ⑥ eSafe® parcel letter box – p. 190



- ① Algarve® 'Classic line' coupled patio cover – p. 68
- ② Linarte® Modulo 55 PLANT – p. 186
- ③ Linarte® Outdoor Light M – p. 185



- ① Algarve® Canvas coupled carport – p. 153
- ② Linarte® Modulo 55 PLANT – p. 186
- ③ Linarte® Outdoor Light S – p. 185
- ④ Linius® fixed wall in Algarve® Canvas – p. 122



- ① Camargue® coupled patio cover – p. 52
- ② Camargue® Skye patio cover – p. 53
- ③ Linarte® Outdoor Light M – p. 185
- ④ Linarte® Modulo 55 PLANT – p. 186
- ⑤ Linarte® Modulo 97 SIT – p. 186
- ⑥ Loggia® sliding panels – p. 178
- ⑦ Linarte® façade element – p. 166



- ① Camargue® patio cover – p. 29
- ② Linarte® freestanding wall – p. 166
- ③ Linarte® Modulo combination PLANT – p. 186
- ④ Linarte® façade element – p. 166
- ⑤ Algarve® Canvas coupled carport – p. 149
- ⑥ Linarte® ICON freestanding wall – p. 188
- ⑦ Linarte® façade element with LED lighting and wood inserts – p. 166
- ⑧ Linarte® Outdoor Light M – p. 185
- ⑨ eSafe® parcel letter box – p. 190





PATIO COVERS

Thanks to a Renson® patio cover, you can enjoy your outdoor space even more. The possibilities to protect yourself from the wind, sun, rain, or cold are numerous and the expansion and personalization possibilities are varied. This makes your garden or terrace a natural extension of your home so that you can spend time outside in optimal conditions and the greatest comfort.

HORIZONTAL DESIGN



LOUVERED ROOFS
(rotatable
louvered roof)

LOUVERED ROOFS
(rotatable and retractable
louvered roof)

FIXED ROOF

CAMARGUE® LINE

CAMARGUE®



Perfectly integrated side elements can be added to this innovative and modular patio cover.

ALGARVE® LINE

ALGARVE®



A horizontal, waterproof sun protection roof with rotatable aluminium blades. Side elements can be surface-mounted.

ELLICE®

ELLICE®



A horizontal, waterproof sun protection roof with rotatable aluminium blades.

AERO® LINE

AERO®



A horizontal, waterproof sun protection roof with rotatable blades that can be integrated perfectly into new or existing structures.

CAMARGUE SKYE®



A fully closable patio cover with rotatable aluminium blades that slide open. Again, side elements can be integrated seamlessly.

ALGARVE CANVAS®



A patio cover with a fixed roof, aesthetically finished with a tension ceiling using Fixscreen technology.

AERO CANVAS®



A patio cover with a fixed roof, finished with an aesthetic tension ceiling using Fixscreen technology. Can be integrated into new or existing structures.

INCLINED DESIGN



RETRACTABLE
FIXSCREEN ROOF

LAGUNE®

LAGUNE®



This patio cover has a translucent wind and waterproof sun protection screen in its roof structure. Side elements can be integrated seamlessly.

LAPURE®

LAPURE®



A minimalist covering with a wind and waterproof sun protection screen roof and an open, panoramic view. Side elements can be surface-mounted.



CAMARGUE® LINE

CAMARGUE® & CAMARGUE SKYE®

Inspiration	30
Features	
• Camargue®	52
• Camargue Skye®	53
• Installation options	54
Accessories	
• Lighting	110
• Heating and sound	113
• Translucent blades - Lineo® Luce	114
Side infills	
• Intro	116
• Outdoor curtains	117
• Glass sliding panels	118
• Loggia® sliding panels	120
• Linius® and Linarte® side elements	122
• Loggia® quick passage / sliding door	124
• Integrated Fixscreen®	125
- Fibreglass fabric Fixscreen®	127
- Crystal screen	128



Camargue®



Camargue®



Camargue®



PATIO COVERS

CAMARGUE® LINE

Camargue®



Camargue®

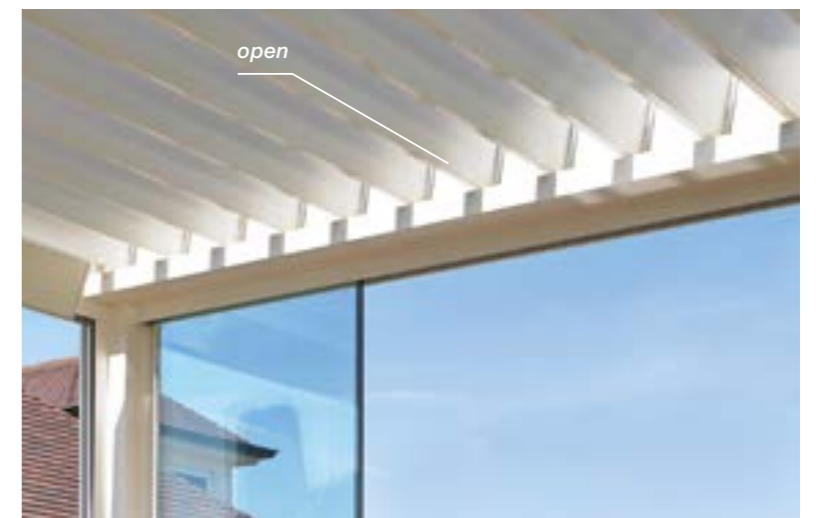
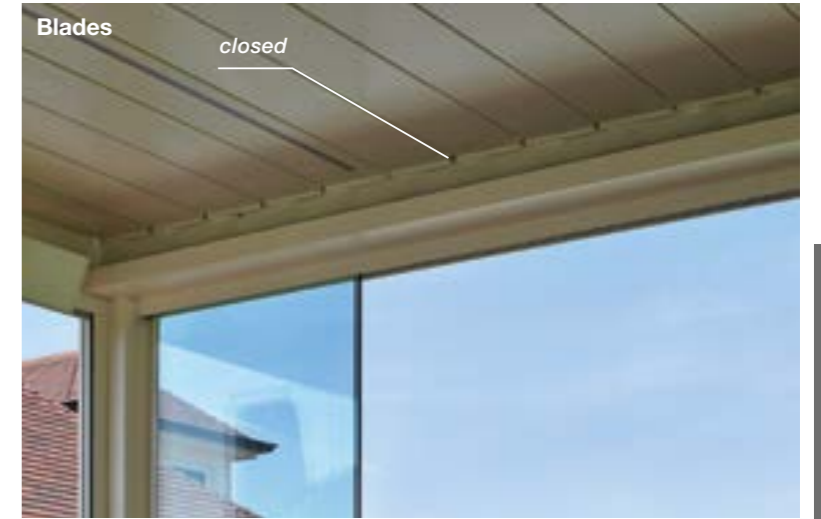
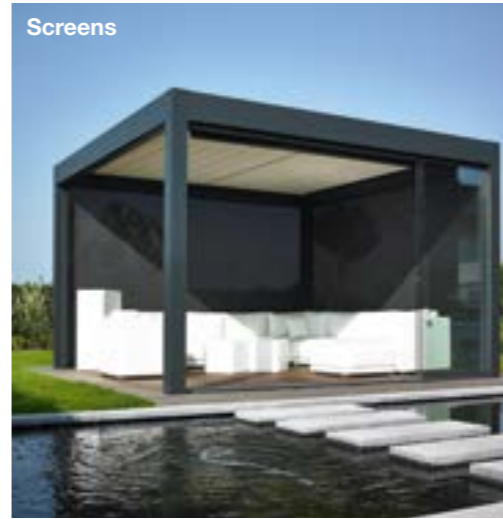



Loggiascreen® Canvas

Loggialu® Stirata



Integrated LED lighting so you can enjoy yourself until late in the evening

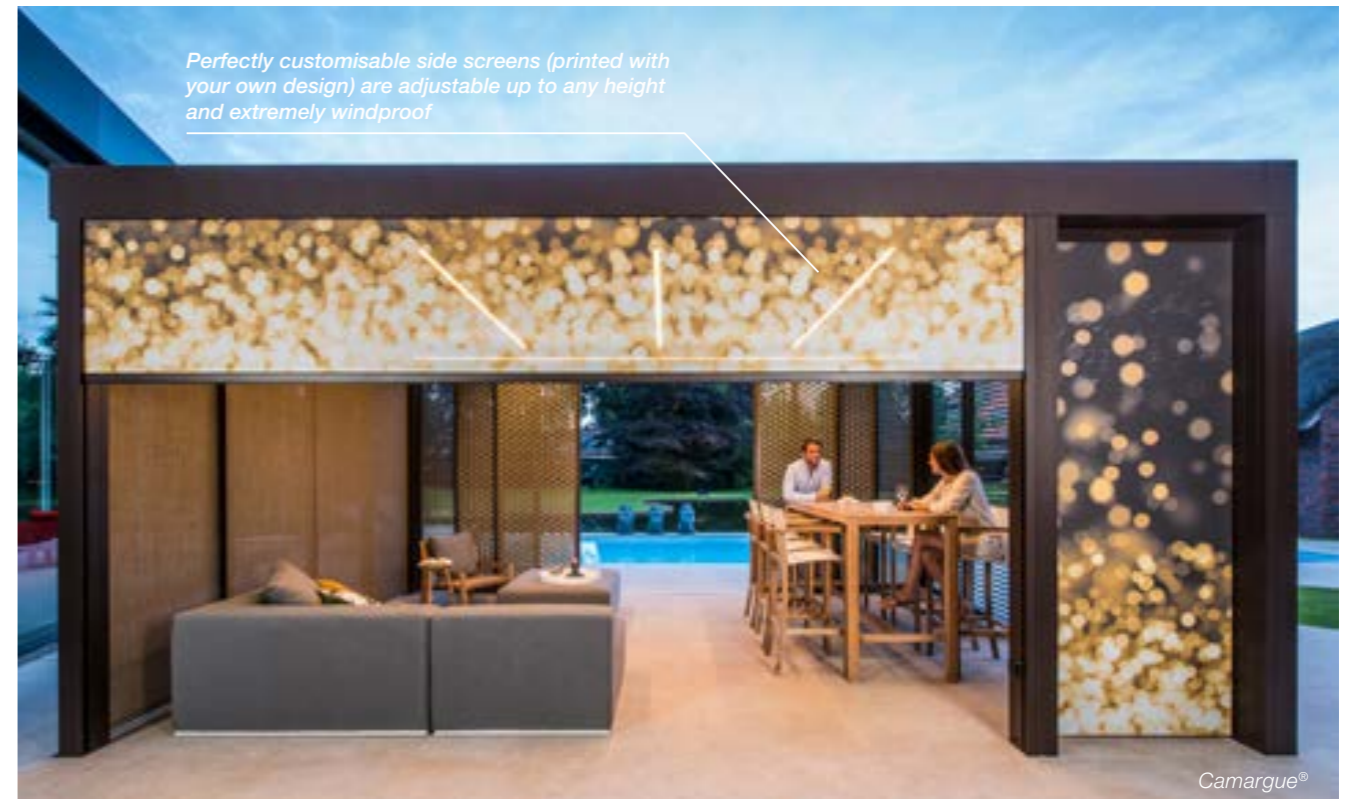

Perfectly customisable side screens (printed with your own design) are adjustable up to any height and extremely windproof



CUSTOM-MADE
TO ANY PERSON'S
TASTE

PATIO COVERS

CAMARGUE® LINE





Camargue®



PATIO COVERS

CAMARGUE® LINE

Camargue®



CAMARGUE® LINE PATIO COVERS

Camargue® & Camargue® Skye

RENSON



Camargue® & Camargue® Skye



Camargue® & Camargue® Skye

Construction against your facade is possible ...



Camargue®

FIBREGLASS
FABRIC ENSURES
ELEGANT
AND STRONG
SHIELDING

PATIO COVERS

CAMARGUE® LINE

“

EVEN MORE ENJOYMENT

DRIES & MONICA

After living in the city centre for years, we built our dream home in the suburbs a few years ago. Finally, we had a garden, a quiet setting and nature that would bring us the peace we were seeking. We discovered that we could not enjoy our garden enough. The wind blows often in the spring; then it can sometimes get too hot in the summer.

In late summer, the evening cools down quicker and you have more regular showers. By installing a patio cover, we can enjoy many more moments outside. The side construction protects us from the wind whilst the screens can be adjusted to the desired height in the summer; in the event of a sudden shower, we can close the roof blades.

The time we can live outside after our working days has increased and our garden has become an asset for our quality of life.



PATIO COVERS

CAMARGUE® LINE

Camargue®

RENSON

49



Camargue®



Camargue®



Camargue®

PATIO COVERS

CAMARGUE® LINE



Camargue®

CAMARGUE®

Fully integrated design solution

The roof is made of extruded aluminium blades that can be rotated to regulate sun protection and ventilation depending on your needs. Control is simple with a Somfy remote control. The roof is waterproof when closed. The water drains off to the columns via the integrated water drainage channels. This water removal system also works when you rotate the blades to the fully open position after it rains, which ensures furniture on the terrace is still protected.



Efficient, integrated water drainage



Controlled water drainage even with the blades open

CAMARGUE SKYE®

Patio cover with retractable louvered roof

The most exclusive addition to the Renson® patio cover range has aluminium blades in the roof which rotate and slide open. The blades offer protection from the rain, sun and wind. Hot air can escape in the summer and you can slide the roof open in the winter to enjoy the sunlight to the fullest. It is still important, especially when the Camargue Skye is mounted to a wall, that sunlight can still shine into the home. The Camargue Skye patio cover's blades are designed in such a way that they drain any precipitation laterally.

All fixations, cabling, and anchoring are invisible and the patio cover can be fitted with LED lights in the columns or profiles, and can also be fitted with a multifunctional design beam with heating elements and speakers. The Camargue Skye can be constructed in several ways: freestanding, fitted to an outside wall, recessed or integrated between two walls. Windproof screens, sliding panels in glass, aluminium, or wood, a fixed wall, and outdoor curtains can also be integrated.



S-Drive Technology

Reliable, durable rotation and retractable technology (tilt & stack) thanks to the patented S-Drive Technology.

- Roof blades can be rotated to allow warm air out and protect from sun, rain, or wind
- Roof blades slide open to allow the maximum amount of light in and provide wide open views
- The roof is perfectly even when closed
- Double-walled blade for greater snow-bearing capacity, and sound and heat insulation
- Synchronised drive on both sides of the blades: the roof will open and close in one smooth movement even when loads are asymmetrical
- No gaps between the blades

INSTALLATION OPTIONS

Types of installation

There are two types of installations for the Camargue Line: freestanding and fitted to an outside wall.



Freestanding: the frame of the Camargue is supported by four vertical columns



Fitted to an outside wall: the frame is placed with one or two sides against an underlying, supporting construction or structure. Vertical columns support the other part. The blades can be positioned parallel or perpendicular to the support structure.

Joinable

The Camargue Line can be extended using one of the larger Spans or Pivots to covering larger surface areas. In this case, a coupling side beam is used.



Camargue coupling on Pivot side



Camargue Skye 2-part coupling on the Span side, similar slide direction and orientation



2-part coupling on the Span side



Camargue coupling on the Pivot and/or Span side



Camargue Skye 2-part coupling on the Span side, opposing slide direction and orientation

Integrated Fixscreen®

By integrating the vertical sun protection, the integrated Fixscreen, with or without Crystal Windows to maximise a view of the outside, you can create an extra outdoor room where the users are protected from sun, rain, and wind. These screens come in 50 colours and allow you to **customise** the Camargue Line and create the atmosphere you desire.



The Camargue Line is fitted with the integrated Fixscreen in the Span and Pivot side

Personalization possibilities

The Camargue Line can have various elements fitted to the front and/or sides. By adding side elements, you create infinite possibilities for customisation.



Loggia sliding panel: Loggiawood, Loggiawood Privacy, Loggiascreen Canvas, Loggialu, Loggialu Privacy



Glass sliding panels + integrated Fixscreen



Loggia sliding door: Loggiascreen Canvas

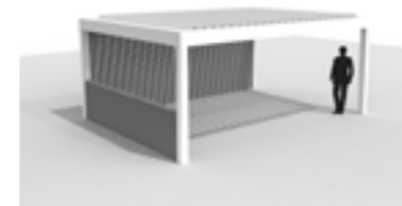

Linius fixed walls: full passage height or desired height



Glass sliding panels

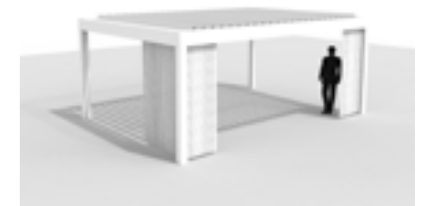

Curtains

Montagevoeten

There are 3 types of mounting bases: visible, invisible, and invisible cast mounting.

If side inserts are used or this is used in locations with increased wind forces, a reinforced mounting base is also available in visible and invisible versions.

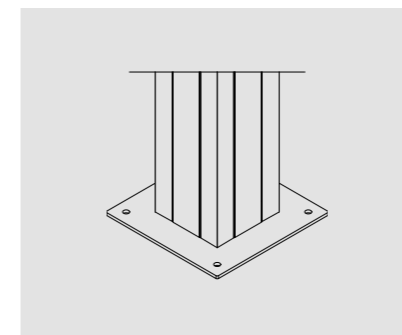

Visible mounting base

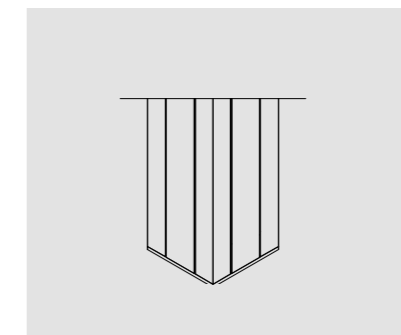

Invisible mounting foot

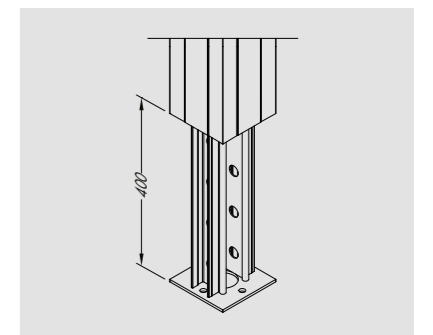

Cast mounting base



ALGARVE® LINE

ALGARVE® & ALGARVE CANVAS®

Inspiration	58
Features	
• Algarve®	68
• Algarve Canvas®	69
• Algarve® 'Classic Line'	68
• Installation options	70
Accessories	
• Lighting	110
• Heating and sound	113
• Translucent blades - Lineo® Luce	114
Side infills	
• Side elements	116
• Outdoor curtains	117
• Glass sliding panels	118
• Loggia® sliding panels	120
• Linus Wall	122
• Surface mounted Fixscreen®	126
- Fibreglass fabric Fixscreen®	127
- Crystal screen	128
• B-screen tension ceiling	131





Algarve® 'Classic Line'



PATIO COVERS

ALGARVE® LINE

CLASSIC
IS ALWAYS
TIMELESS

RENSON

“
A MORE
STRUCTURAL
SOLUTION

KAREL AND GREET

We have chosen a fixed patio cover to protect us from sun or rain depending on the weather. It's been a while since we looked for a more structural solution than a parasol awning or putting out a party tent to take shelter from the rain.

We found this execution to be an excellent fit with the existing architecture of our house and it seemed like a sound solution. It has proven to be even more comfortable than originally thought. We should have installed this much earlier. The blades rotate anyway you like. When it's too hot, we open them slightly so we can feel the breeze. When it rains, the water drains away in no time. We've been using our patio cover for five seasons now and it still looks like new. It is a very solid construction. I clean the blades with **Renson 'Clean'** once every spring and reapply **Renson 'Protect'** to everything, and then we're set for a great new season.

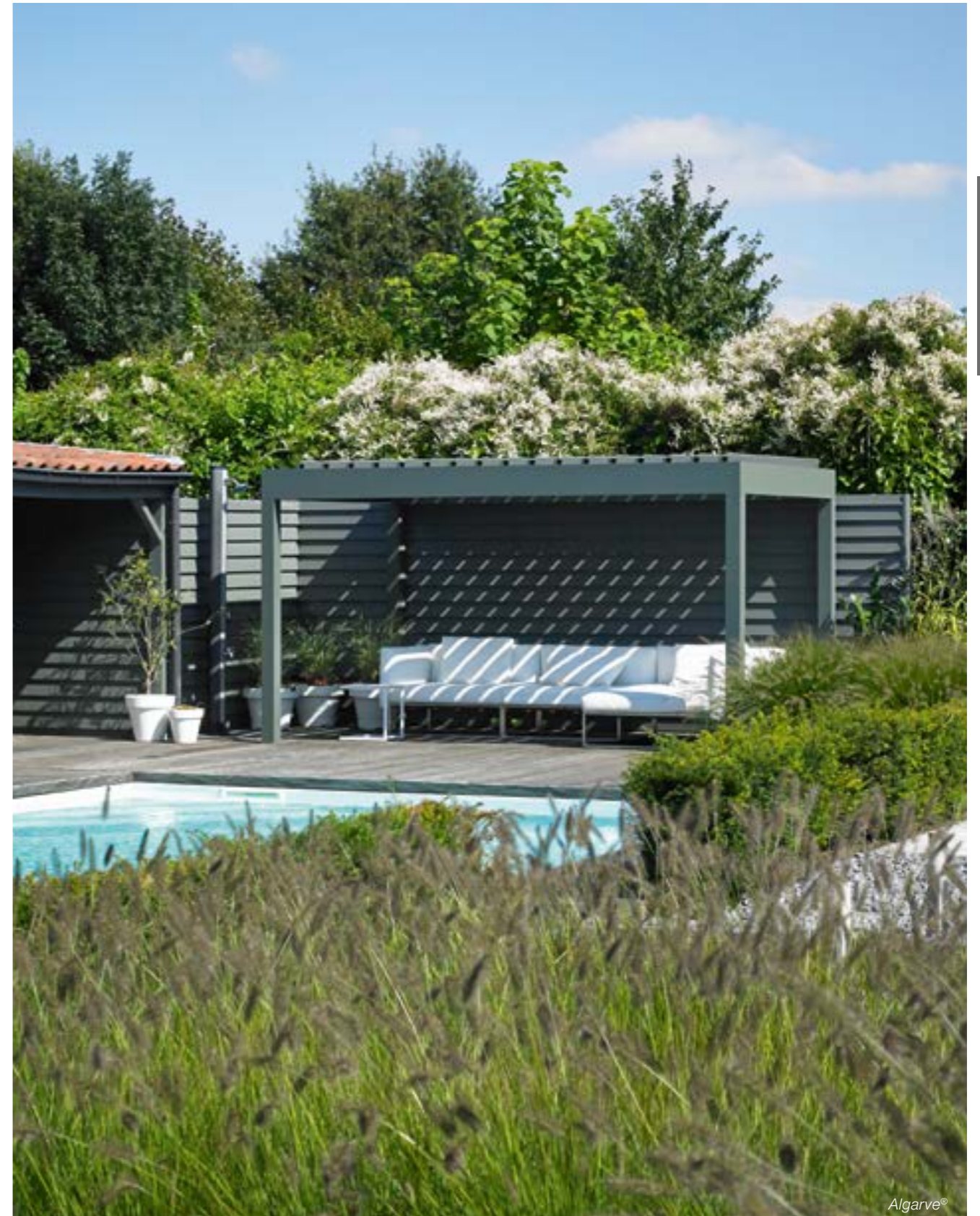



PATIO COVERS

ALGARVE® LINE

Algarve® & Algarve® Canvas

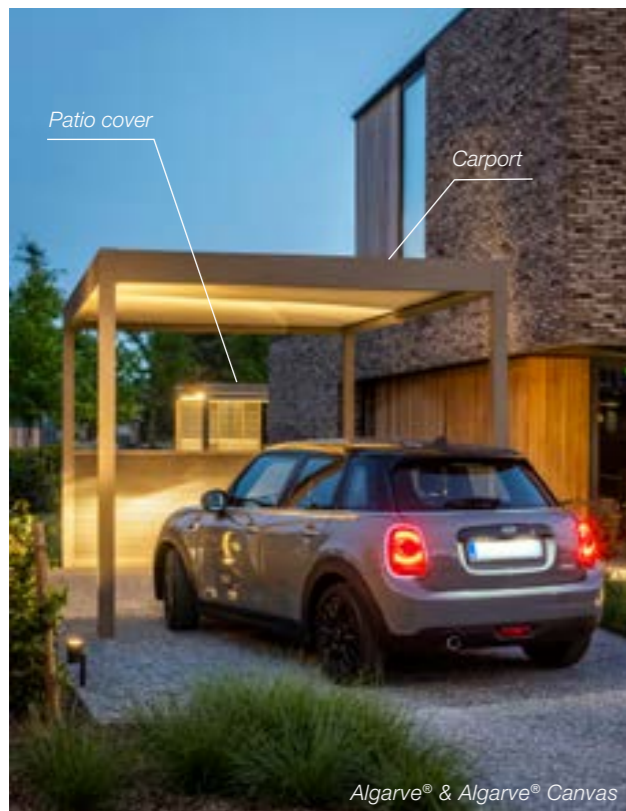

ALGARVE®

Patio cover with horizontal sun protection roof with rotatable blades

This simple, practical patio cover has a sun protection roof with rotatable blades. The extruded aluminium blades can be rotated up to 150°, thus providing the possibility to determine for yourself how much sun protection and/or ventilation you desire. The blades form a waterproof roof when closed. The rainwater is carried to the columns via a drainage gutter. The Algarve fits in with any architectural style, whether its contemporary, classic or modern, thanks to its elegant, light design and availability in all of the RAL colours. Moreover, all the screws are concealed.



Drainage gutter



150° rotation

ALGARVE CANVAS®

This elegant roof offers lasting protection by means of a fixed roof made up of 2 layers: a solid top roof made of white lacquered, profiled steel sheet with anti-condensation coating and an aesthetic lower roof, finished with a stretched canvas with zip technology. The screen is tautly stretched in the structure, without any visible additional beams. It is available in 8 colours. Algarve Canvas is useful as a fixed patio cover, carport or as an awning above the front door, for instance. In addition, a combination of an Algarve with rotatable louvered roof and an Algarve Canvas with fixed roof structure is possible to create a single, uniform style around the house.



Roof section



Water drainage

Algarve® 'Classic Line' Durable patio cover with a beautiful, classic look

Algarve 'Classic Line' is a classic line in the range of patio covers with adjustable aluminium blades in the roof, so that you can determine for yourself how much light hits the terrace, while being protected from the rain when necessary. The classic finish means that the **Algarve 'Classic Line'** provides a durable, maintenance-friendly solution with a beautiful, classic appearance. This patio cover can be mounted to the wall or used as a stand-alone element, making it the ideal solution for a rustic or classic architectural style.



INSTALLATION OPTIONS

Types of installation

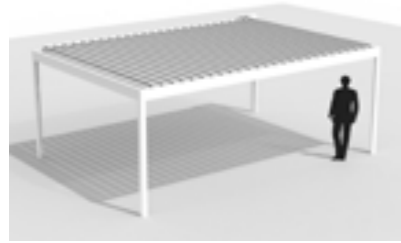

Algarve – Freestanding



Algarve Canvas – Freestanding

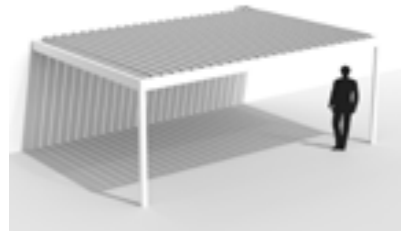

Algarve – Façade mounting

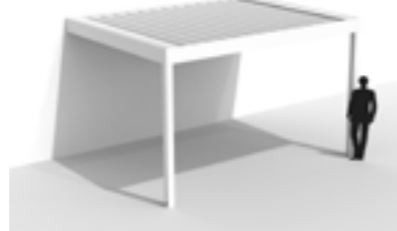

Algarve Canvas – Façade mounting

Personalization possibilities

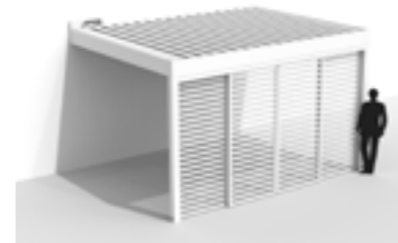

Loggia

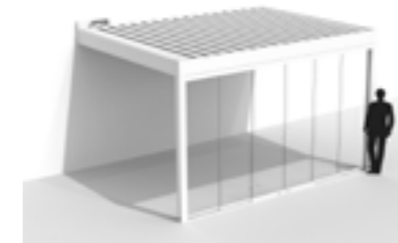

Glass sliding panels



Surface-mounted Fixscreen

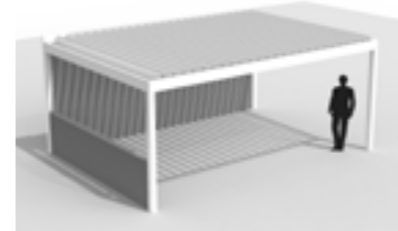

Linius fixed wall

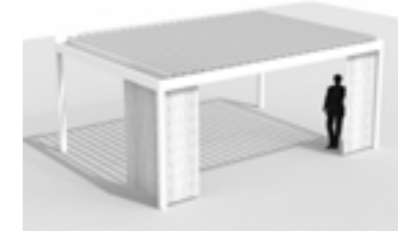

Curtains

**Fixscreen® 100^{EVO} Slim F /
Fixscreen® 150^{EVO} F - Algarve® Line**
To close off the sides of the Algarve Line, it can be combined with the Fixscreen 100^{EVO} Slim F and the Fixscreen 150^{EVO} F. This allows the box for the sun protection screen to be mounted underneath the frame profiles so that this connects perfectly with the basic construction.

Joinable

Algarve can be coupled in two parts (on the Span side) so that exceptional areas of 6 x 6.05 m can be covered without middle columns disrupting the view. Moreover, the Algarve Line in its coupled version is perfectly feasible with a louvered roof in one part of the roof and a fixed roof in the other part.

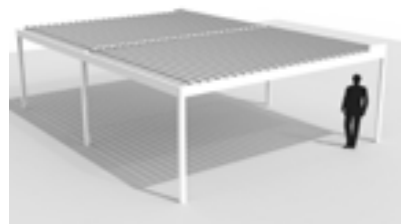

Algarve – 2-part coupling on the Span side



Algarve coupled with Algarve Canvas

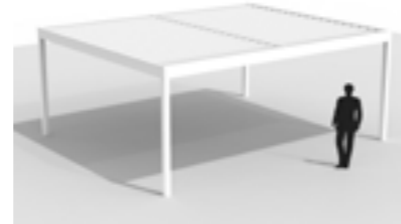

Algarve Canvas – 2-part coupling on the Span side



ELLICE®

Features

- Ellice® 74
- Installation options 75

Accessories

- Lighting 110
- Fixscreen® 126

Side infills

- Surface mounted Fixscreen® 126
 - Fibreglass fabric Fixscreen® 127
 - Crystal screen 128

ELLICE®

Patio cover with horizontal sun protection roof and rotatable blades

This simple, practical patio cover has a sun protection roof with rotatable blades. The extruded aluminium blades can be rotated up to 150°, thus providing the possibility to determine for yourself how much sun protection and/or ventilation you desire. The blades form a waterproof roof when closed. The rainwater is carried to the columns via a drainage gutter. The Ellice fits in with any architectural style, whether its contemporary, classic, or modern, thanks to its elegant, lightweight design, and availability in 20(!) colours.



Drainage



150° rotation

INSTALLATION OPTIONS

Types of installation

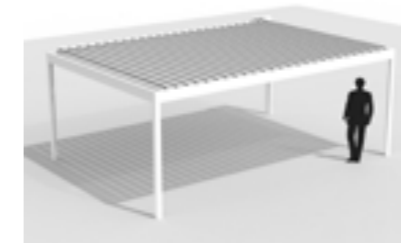

Ellice – Freestanding

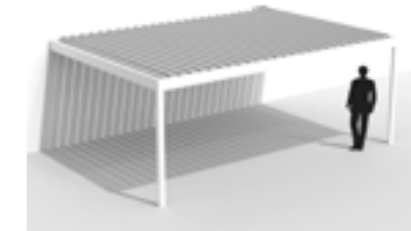

Ellice – Façade mounting

Personalization possibilities

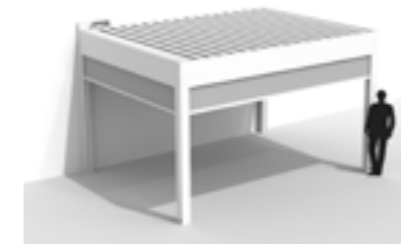

Surface-mounted Fixscreen

Fixscreen® 100^{EVO} Slim F / Fixscreen® 150^{EVO} F - Ellice® Line

To close off the sides of the Ellice, it can be combined with the Fixscreen 100^{EVO} Slim F and the Fixscreen 150^{EVO} F. This allows the box for the sun protection screen to be mounted underneath the frame profiles so that this connects perfectly with the basic construction.



AERO® LINE

AERO®

AERO® CANVAS

Inspiration	78
Features	
• Aero®	86
• Aero® Canvas	87
Accessories	
• Lighting	110
• Heating and sound	113
• Translucent blades - Lineo® Luce	114



Aero®



Aero®

PATIO COVERS

AERO® LINE



Aero®



Aero®



PATIO COVERS
AERO® LINE

SEAMLESS
INTEGRATION
FOR A REFINED
LOOK



Modern



Classic



PATIO COVERS
AERO® LINE

AERO®

Horizontal sun protection roof with adjustable blades that can be integrated into existing constructions

This simple roof structure, without columns but with rotatable blades, creates a sun protection roof. The extruded aluminium blades can be rotated up to 150°, thus providing the possibility to determine for yourself how much sun protection and/or ventilation you desire. The blades form a waterproof roof when closed. The rain water is carried to the corners via a drainage gutter. The Aero fits in with any architectural style, whether its contemporary, classic or modern, thanks to its elegant, light design and availability in all of the RAL colours.

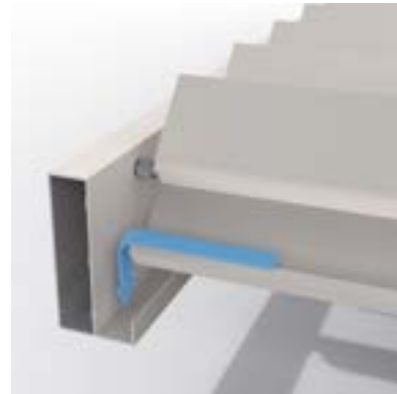

Drainage gutter

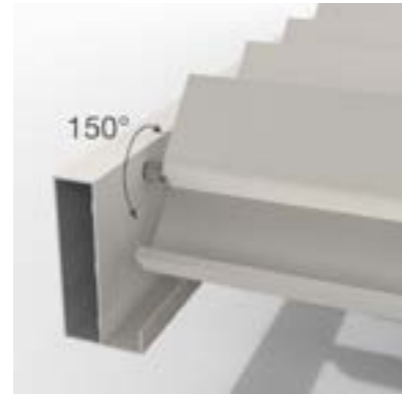

150° rotation



AERO® CANVAS

Minimalist covering that can be integrated into an existing or new support structure

Aero Canvas is equipped with a fixed roof, consisting of two layers: an upper roof and a lower roof. The upper roof is extremely sturdy and constructed from lacquered, profiled steel sheets with an anti-condensation coating. The lower roof creates a sleek, aesthetic look and is finished with a tautly stretched fabric using Fixscreen Technology. All techniques are concealed completely invisibly: from screw connections to water drainage. The optional UpDown lighting ensures that this architectural roof is also attractively accentuated at night. The Aero Canvas fits in with any architectural style, whether its contemporary, classic or modern, thanks to an elegant, light design and availability in all of the RAL colours.

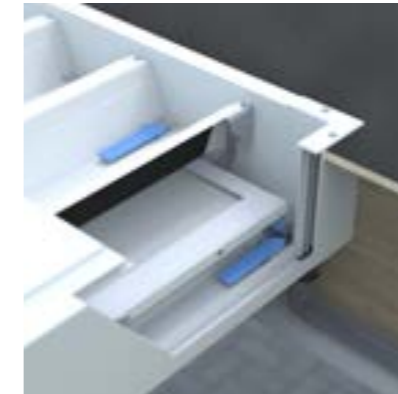

Drainage gutter



Roof section





LAGUNE®

Inspiration	90
Features	
• Lagune®	93
• Construction situations	94
• Personalization possibilities	95
Accessories	
• Lighting	110
• Heating and sound	113
Side infills	
• Side elements	116
• Glass sliding panels	118
• Loggia® quick passage / sliding door	124
• Integrated Fixscreen®	125
- Fibreglass fabric Fixscreen®	127
- Crystal screen	128
• Soltis® proof W96 waterproof screen roof	130



Lagune®



Lagune®



The roof can be adjusted to the position that best suits your current needs

Lagune®

PATIO COVERS

LAGUNE®



Lagune®

LAGUNE®

Patio cover with innovative, transparent fabric in the roof structure

This patio cover consists of an **aluminium structure** with **integrated Fixscreen technology**. The sun protection is completely integrated into the structure, creating an aesthetic unit. Thanks to the modular structure, the entire unit is easy to expand, even afterwards. The **Fixscreen technology** combined with **optimum screen tension** ensures that rainwater is drained via the guiding channels hidden within the structure. Even if the sun protection screen is not fully unrolled, the water that falls on it, is drained away via this **integrated water-drainage system**. A great deal of attention is also given to the **quality of the finish**. For example, the fixation parts are **practically invisible**, all of the electrical cables are hidden, and invisible floor mounting is also possible. The Lagune's high-quality materials and design **keep maintenance to a minimum**, while simultaneously guaranteeing **exceptional durability**. The Lagune fits in with **any architectural style** thanks to its availability in all of the RAL colours and the various personalization possibilities.



Integrated water drainage



Integrated water drainage

Construction situations



Construction situation 1 – Against a supporting construction (standard)



Construction situation 2 – Against a supporting, left- and right-side construction



Construction situation 3 – Against a supporting and left-side construction



Construction situation 4 – Against a supporting and right-side construction

Integrated Fixscreen®

By integrating the vertical sun protection, the integrated Fixscreen, with or without Crystal Windows to keep a view of the outside, you can create an extra outdoor room where the users are protected from sun, rain, and wind. These screens come in 50 colours and allow you to **customise** the Lagune and create the atmosphere you desire.



Lagune is fitted with multiple integrated Fixscreens in the Front

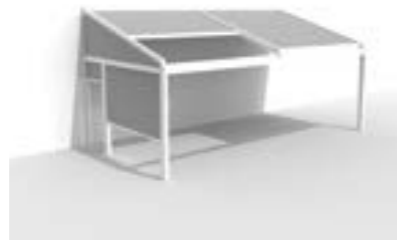

Lagune is fitted with multiple integrated Fixscreens in the Side

Types

There are four basic models, depending on the width of the Lagune:



Basic model 1
1500 mm < width ≤ 4000 mm



Basic model 2
4000 mm < width ≤ 6000 mm



Basic model 3
6000 mm < width ≤ 8000 mm



Basic model 4
8000 mm < width ≤ 12000 mm

Personalization possibilities

Lagune can have various elements fitted to the front and/or sides. By adding side elements, you create infinite possibilities for customisation.

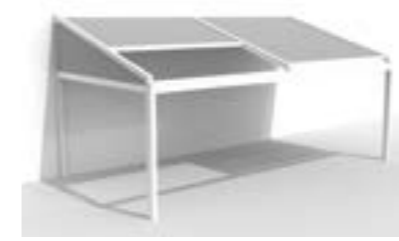

Triangle



Integrated Fixscreen

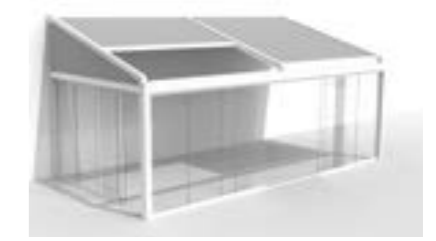

Glass sliding panels



Loggia sliding wall in Loggiawood / Loggialu Wooddesign / Loggiascreen Canvas / Loggialu / Loggialu Stirata / Loggialu Plano / Loggiawood Linea



Loggia sliding door: Loggiascreen Canvas

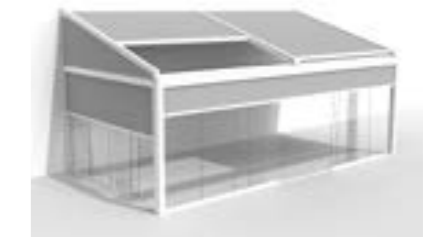

Glass sliding panels + Integrated Fixscreen

Triangle - Lagune®

In order to make the integration possible in the Lagune Side, it is necessary to fit this with the Lagune Triangle. Lagune is fitted with a vertical wall profile and an additional box in this case. The triangle that is created between the Lagune's box and side channel is filled with a fibreglass fabric of your choosing.

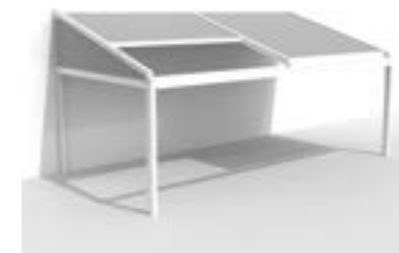

Lagune®



LAPURE®

Inspiration 98

Features

- Lapure® 102
- Types 103

Accessories

- Lighting 110

Side infills

- Side elements 116
- Loggia® quick passage / sliding door 124
- Fixscreen® 126
- Fibreglass fabric Fixscreen® 127
- Crystal screen 128
- Soltis® proof W96 waterproof screen roof 130



PATIO COVERS

LAPURE®

Lapure®



Lapure®



Lapure®



LAPURE®

Minimalist patio cover with water and sun protection Fixscreen® screen roof

The stylish, minimalist Lapure consists of a windproof, waterproof, sun protection screen roof that rests on elegant, discrete aluminium columns with no disruptive lateral connection. It is anchored to an existing façade. When the roof is closed, the Lapure provides protection from the sun, wind and rain. When the roof is open, you can enjoy the sun as the delicate structure is not visually disruptive. There are two types of columns for the Lapure: 'end columns' with water drainage (via side channels and columns). Or you can also opt for 'shifted columns' (with roof overhang and water drainage via gutters, even when half open). The latter has a roof overhang that juts out past the columns as to provide the optimum amount of shade. This lets you enjoy enough shade, even when the sun is low in the sky, for instance. A 'coupled' version is also possible so that two or more roofs can be perfectly placed next to each other to span large dimensions (only 1 column when coupled).

Thanks to the wide range of colours for the structure, the Lapure blends in to every environment and suits every architectural style.

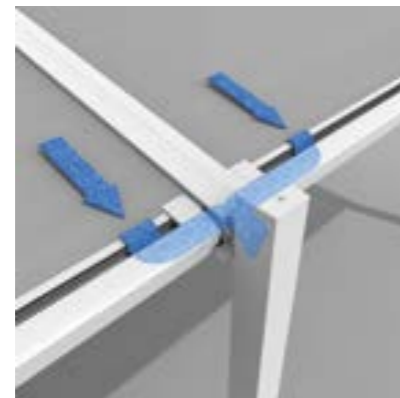

Coupled version with end column

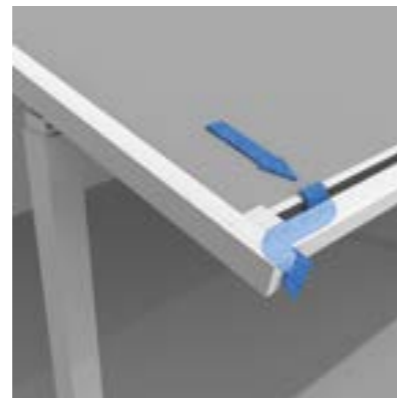

With shifted columns

Types

1 roof section

Without roof overhang
(with 'end columns')

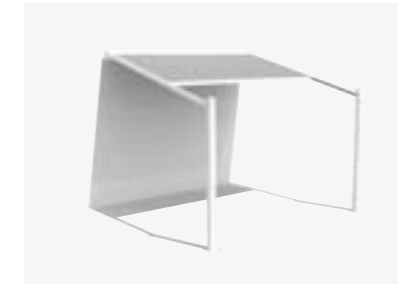

With roof overhang
(with 'shifted' columns)



2 roof sections



3 roof sections

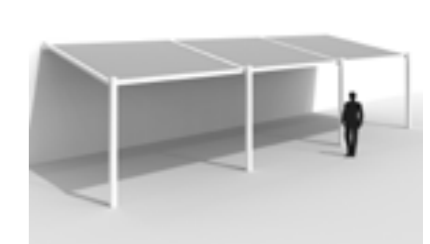

Personalization possibilities



Lapure fitted with an integrated Fixscreen and sliding door using Loggiascreen Canvas in the Side

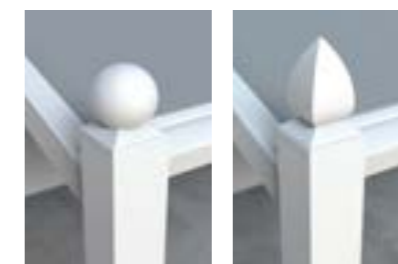

The Lapure 'Classic Line' creates a classic, traditional style by adding decorative elements: stylised columns and finials in a globe or diamond shape.



1 roof section between 4 and 6 m: including a cross-beam (with or without LED)

ALSO IDEAL FOR PENTHOUSES AND APARTMENT ROOFS

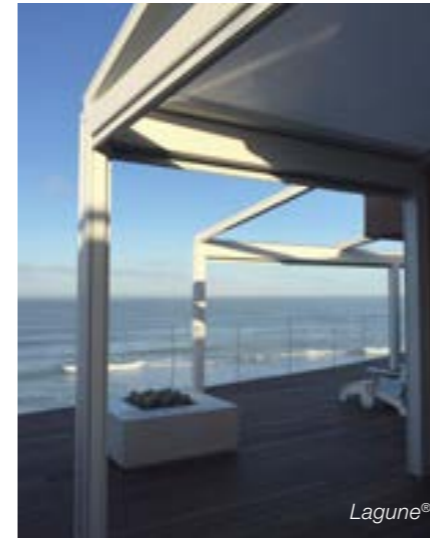

PATIO COVERS



APARTMENTS





CUSTOMISATION

Accessories

- Lighting 110
- Heating and sound 113
- Translucent blades - Lineo® Luce 114

Side infills

- Side elements 116
- Outdoor curtains 117
- Glass sliding panels 118
- Loggia® sliding panels 120
- Linius Wall 122
- Loggia® quick passage / sliding door 124
- Integrated Fixscreen® 125
- Surface mounted Fixscreen® 126
- Fibreglass fabric Fixscreen® 127
- Crystal screen 128
- Soltis® proof W96 waterproof screen roof 130
- B-screen® tension ceiling 131
- Aluminium colour selection 132
- Automation 132

LIGHTING, HEATING, AND MUSIC

ENJOY EVERY MOMENT OF THE DAY

When it starts to get dark, you simply switch on the integrated **lighting**. The choice of lighting lets you create the desired mood and feeling.

You can continue to enjoy your terrace, even when it starts getting colder. **Heating elements** can be provided to make this possible. The radiated heat ensures an even distribution of warmth throughout the space with minimum heat loss. And thanks to the integrated flat panel speakers, you can even enjoy your favourite music on your terrace.

Lighting

You can choose between cool or warm white lighting to create the desired mood and feeling. Moreover, the LED lighting in most patio covers can be **dimmed** so that the intensity of the lighting can be adjusted to the situation. The lighting for **Lagune** and **Lapure** is integrated into the roof structure. You can opt for LED lighting that is integrated into the roof blades in **Camargue Line**, **Algarve Line**, and **Aero Line**. Upwards or downwards lighting can also be provided on the inside of the frame. With **Camargue** and **Camargue Skye**, atmospheric lighting is also available in the columns.

You can choose between warm white light (perfect for cosy gatherings with friends), pure white light (perfect for reading) and RGB (only for uplighting in the frame) to create the desired mood and feeling. Moreover, the LED lighting can be dimmed so that the intensity of the lighting can be adjusted to the situation. The Renson® LED lighting's exceptionally durable quality ensures even lighting without any bright spots. **Algarve Canvas** and **Camargue Skye** can be equipped with atmospheric UpDown LED lighting.

	Warm white light	Pure white light	RGB (colour)	Dimmable
Lagune® LED Light**	✓	✓		✓ (io)
Lineo® LED Light*	✓	✓		✓
Colomno LED Light**	✓	✓		✓
UpDown LED Light** Upwards	✓	✓	✓	✓
UpDown LED Light** Downwards	✓	✓		✓
Lapure® LED Light*	✓	✓		✓

* Warm white: 1660 lm/m (180 LEDs/m) / Pure white: 1660 lm/m (180 LEDs/m)

** Warm white: 550-680 lm/m (120 LEDs/m) / Pure white: 550-680 lm/m (120 LEDs/m) / RGB: 550-700 lm/m (60 LEDs/m)



Colomno LED Light

LED lighting integrated into the columns – **Camargue Line**. A maximum of one LED strip can be integrated into each column (on the inside of the column). There can be a total of four columns fitted with integrated LED Light lighting per roof section.



UpDown LED Light

Integrated LED lighting on the inside of the frame. Fitted with lighting running upwards and/or downwards. This lets you create indirect or direct atmospheric lighting with the **Camargue Line**, **Algarve Line**, and **Aero Line**. A total of two UpDown LED lighting modules can be installed per roof section. This can be done on either the Pivot side or the Span side.



Lagune® LED Light

Integrated LED lighting in the side channels of the Rooffix – **Lagune**. Even distribution without visible bright spots thanks to high-quality LEDs (180 per metre).



Lineo LED Light

LED lighting integrated into the blades – **Camargue**, **Algarve** and **Aero**. Even distribution without visible bright spots thanks to high-quality LEDs (180 per metre).



Lapure® LED Light

LED lighting integrated into the Lapure cross-beam. Even distribution without visible bright spots thanks to high-quality LEDs (180 per metre).



Heating and sound

Integrated LED lighting, heating and sound are the perfect complement to the **Camargue Line**, **Algarve Line**, **Aero Line** and **Lagune**. Thanks to these extra features, the patio cover can be used from early morning to late evening, all year round. Moreover, these additions can be perfectly integrated afterwards.

Beam design beam with Heat & Sound

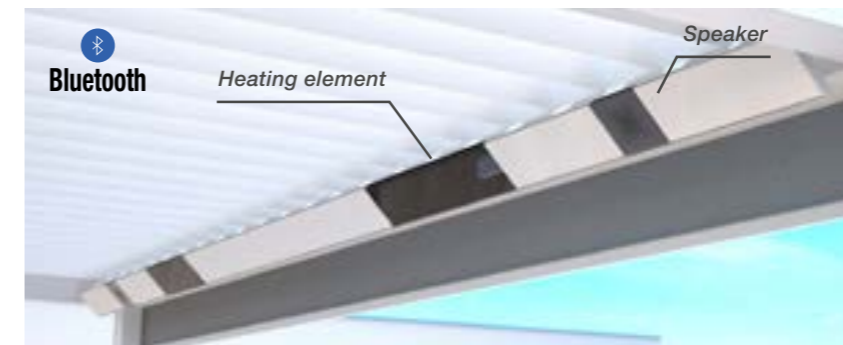

Integrated heating elements and speakers

Heated enclosures

To enjoy your heater to the fullest, we recommend adding components (such as glass walls, Fixscreen, etc.) that will enclose the patio cover.

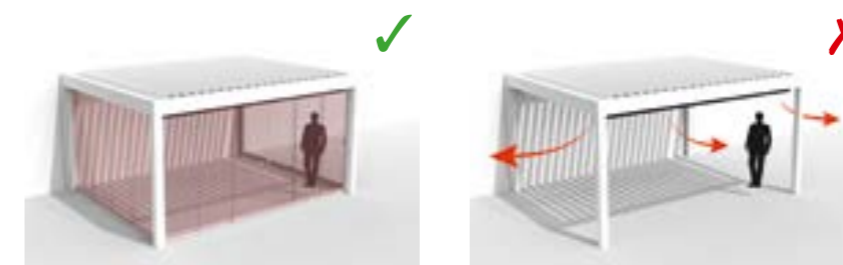

Perfect heater position

The perfect position for the heater is across from the fixed wall so that you can enjoy the reflected heat.

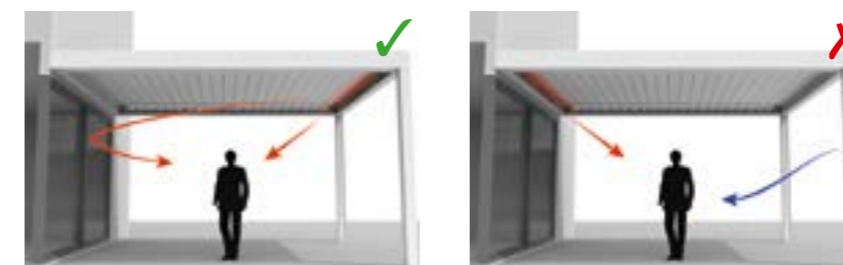

How long does it take the heater to reach maximum heat?

Because we work with a short-wave system, the heater reaches maximum radiated heat levels almost immediately. Short-wave radiated heat is directly palpable, similar to the heat of solar radiated heat. You heat up the objects and not the space.

Long-wave infrared heaters have a longer warm-up time than the short-wave heaters. They need the air to transfer the heat; depending on the ambient temperature, size of the covering or if it's closed or not. It can take some time before you feel this radiated heat to the maximum.

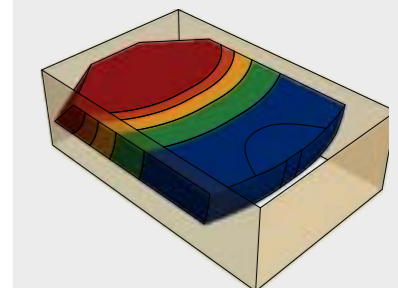

Heat effect with 1 side heated (6 x 4 m format)

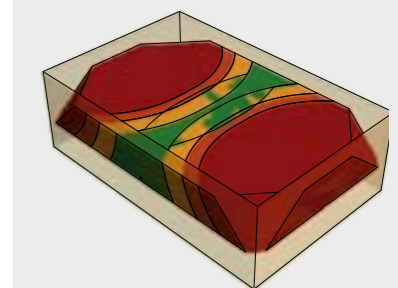

Heated effect with 2 sides heated (6 x 4 m format).

LINEO® LUCE

(TRANSLUCENT BLADES FOR
CAMARGUE®, ALGARVE® AND AERO®)

Increased elegance thanks to completely transparent blades

Renson® offers the option to integrate translucent **glass blades**, specifically Lineo Luce, into the Camargue, **Algarve** and **Aero**, when these have adjustable aluminium blades.

When you fit part of your patio cover with translucent blades, you create a sense of more openness. This is a way to bring more light inside when adding on to your home.

A total of five translucent blades can be installed per roof section with a maximum width of 4 m. These can either be put all together or spread out across the whole of the roof section.

The ideal solution for letting the light in even when the roof is closed!



Light entering the home with roof closed



Light under the patio cover with roof closed

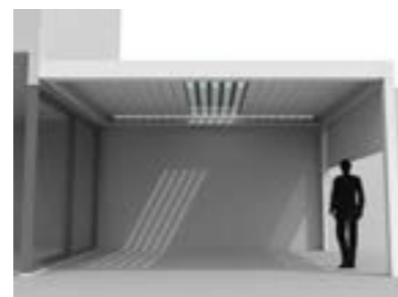

SIDE ELEMENTS

ENDLESS PERSONALIZATION POSSIBILITIES

All patio covers can have various elements (such as sun protection fabric, sliding panels, glass walls, etc.) fitted to the front and/or sides. This means there are endless options for customisation. The front and/or the sides can be fitted with vertical sun protection.

Lowered windproof, motorised Fixscreens create a protective cocoon. Thanks to the partial transparency of the screens and the use of Crystal windows, you don't lose the view of the garden. You've also got a wide range of colours to choose from. Every colour combination is possible and can perfectly be matched with other materials, such as the garden furniture. In the open position, the **integration of the screens is invisible** and the motors are also completely concealed in the structure. You can also opt for **glass sliding panels**. When combined with windproof screens, you also retain the benefit of the sun protection. Elegant **Loggia** sliding panels with windproof fabric screens or (adjustable or fixed) wooden or aluminium blades are also an option. Wood (particularly cedar) has made a comeback and is easy to combine with other materials. You can even opt for a two-toned colour finish when you combine sliding panels with aluminium blades.



OUTDOOR CURTAINS

(FOR CAMARGUE® LINE AND ALGARVE® LINE)

Fitted with curtains for outdoor use

Both the **Camargue Line** and **Algarve Line** can be fitted with outdoor curtains. This allows you to create a fairy-tale atmosphere under your patio cover. These polyester curtains are for outdoor use and are waterproof, mould-resistant and repel dirt. Moreover, these are weather-resistant and colour-fast, even after washing. The curtains are completely wrinkle-free. The curtains can be completely made to order. Moreover, they can be combined with glass sliding panels and integrated Fixscreens in the Camargue Line. The outdoor curtains are always combined with UpDown LED lighting. This gives the patio cover a romantic feel at twilight.



GLASS SLIDING PANELS

(FOR CAMARGUE® LINE, ALGARVE® LINE AND LAGUNE®)

Increased elegance thanks to completely transparent sliding walls

You can also choose to install glass sliding panels. These completely transparent sliding walls increase the elegance of the **Camargue Line**, **Algarve Line** and **Lagune**. This also protects you from the weather and wind, and for security measures, the patio can be completely enclosed to prevent theft. You can of course always integrate the vertical, windproof Fixscreen sun protection together with a glass sliding panel, which keeps the major advantage of sun protection. Plus, you can combine the glass wall with the outdoor curtains, even when already combined with the integrated Fixscreens.

Integration

Camargue Line & Algarve Line: available in Span and/or Pivot

Lagune: available in Side and/or Front



The Camargue Line is fitted with glass sliding panels and integrated Fixscreens in the Span and Pivot side



The Lagune is fitted with glass sliding panels in the Side and Front

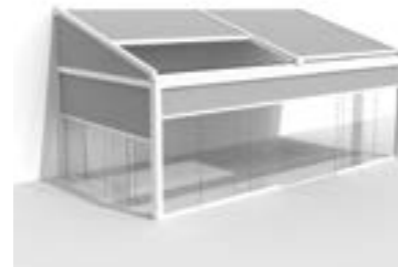

The Lagune is fitted with glass sliding panels and integrated Fixscreen in the Side and Front

DISTRIBUTION OF GLASS SLIDING PANELS

Diagram	Diagram	Diagram	Diagram
1500 ≤ X ≤ 2500 Width X	2500 < X ≤ 3750 Width X	3750 < X ≤ 5250 Width X	5250 < X ≤ 6500 Width X
3 panels	4 panels	6 panels	8 panels
3 rails	4 rails	3 rails	4 rails
Opens to the left or opens to the right	Opens to the left or opens to the right	Opens to the left and opens to the right	Opens to the left and opens to the right
Incl. 1 handle	Incl. 1 handle	Incl. 2 handles	Incl. 2 handles



LOGGIA® SLIDING PANELS

(FOR CAMARGUE® LINE, ALGARVE® LINE AND LAGUNE®)

You control the amount of light that comes in

With the vertical sun protection sliding panels, you can even influence the way sunlight penetrates under your patio cover (dynamic sun protection). The sliding sun protection panels are made of aluminium frames with:



Types

- Loggiawood: wooden blades (Western Red Cedar)
- Loggiawood Privacy: rotatable wooden blades (Western Red Cedar)
- Loggiascreen Canvas: fabric screen (fibreglass)
- Loggialu: aluminium blades
- Loggialu Privacy: rotatable aluminium blades
- Loggialu wooddesign: aluminium blades with wooddesign
- Loggialu Stirata: expanded metal
- Loggiawood Linea: wooden slats (WRCedar)

Integration

Camargue Line: available in Span and/or Pivot

Algarve Line: available in Span and/or Pivot up to 4500 mm

Lagune: available in Side



Camargue Line fitted with Loggiawood sliding panels on the Span side



Lagune fitted with Loggiawood sliding panels on the Side

Privacy

Manually adjustable wooden or aluminium blades. The **Privacy** version of the Loggiawood and Loggialu sliding panels have blades that can be rotated manually to be fully open or closed.



UNIQUE: Loggia sliding panels and roof blades in the same wood design

Wooddesign

Camargue Line, Algarve, and Aero Linefitted with aluminium roof blades in wood design

- Natural appearance of wood combined with the advantages of aluminium in terms of:
 - Ease of maintenance
 - Colourfastness
 - Maintains the shape
- Also available for the LED blades
- Combines perfectly with the Loggialu Wooddesign sliding panels
- Roof blade in wooddesign (frame and columns have standard coating)
- Available in 3 types:
 - White oak
 - Natural oak
 - Walnut

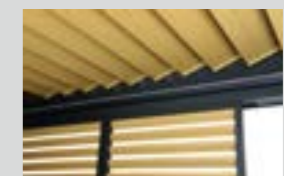

White oak

Natural oak

Walnut

LINIUS & LINARTE FIXED WALL

(LINIUS FOR CAMARGUE® LINE AND ALGARVE® LINE &
LINARTE FOR CAMARGUE® LINE)

Physical barrier or decorative finish for the supporting wall

The Linius or Linarte bladed wall lets you create a physical barrier and decorative finish for the supporting wall. The fixed wall is available as a single or a double-sided, cladded wall across the entire passage height, or can be finished at a customised height with a top profile to create a railing. Ideal as a border for terraces or balconies in the hotels, restaurant, and catering sector. The Linarte fixed wall is always available with tautly stretched screen at one side.

The support structure ensures that the connection between the finishing blades is not visible, which creates an unbroken line along the entire width. The wall fits neatly into the space in the columns on both the front and back sides. Height differences in the floor up to 6 cm are compensated by the finishing plinth, so that no annoying openings are visible at the bottom. The wall is custom-finished in the colour of the covering or of your choosing. Moreover, the double-sided wall allows for the application of sound proofing. This way you can enjoy the nature around your covering in utter relaxation.



Linius fixed wall, full height, single or double-sided

LOGGIA® QUICK PASSAGE / SLIDING DOOR

(FOR CAMARGUE® LINE, LAGUNE® AND LAPURE®)

Perfect for when the patio cover is completely enclosed (using Fixscreen, for instance) and you want to have a sliding door from in or out of the patio cover without having to open the Fixscreen (the comfort of those sitting under the patio cover is maintained). The sliding door consists of an aluminium frame covered on one side with a glass fibre screen of your choice.

Integration

Camargue Line: available in Span and/or Pivot

Lagune: available in Side and/or Front

Lapure: available in Side

Width: min. 800 mm – max. 1200 mm



Camargue fitted with an integrated Fixscreen and sliding door using a Loggiascreen Canvas in the Span side



Lagune fitted with an integrated Fixscreen and sliding door using a Loggiascreen Canvas in the Side



Lagune fitted with an integrated Fixscreen and sliding door using Loggiascreen Canvas in the Front

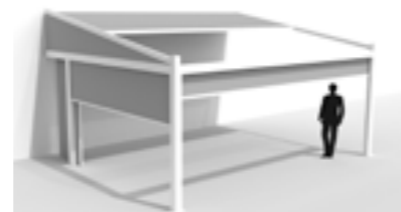

Lapure fitted with an integrated Fixscreen and sliding door using Loggiascreen Canvas in the Side

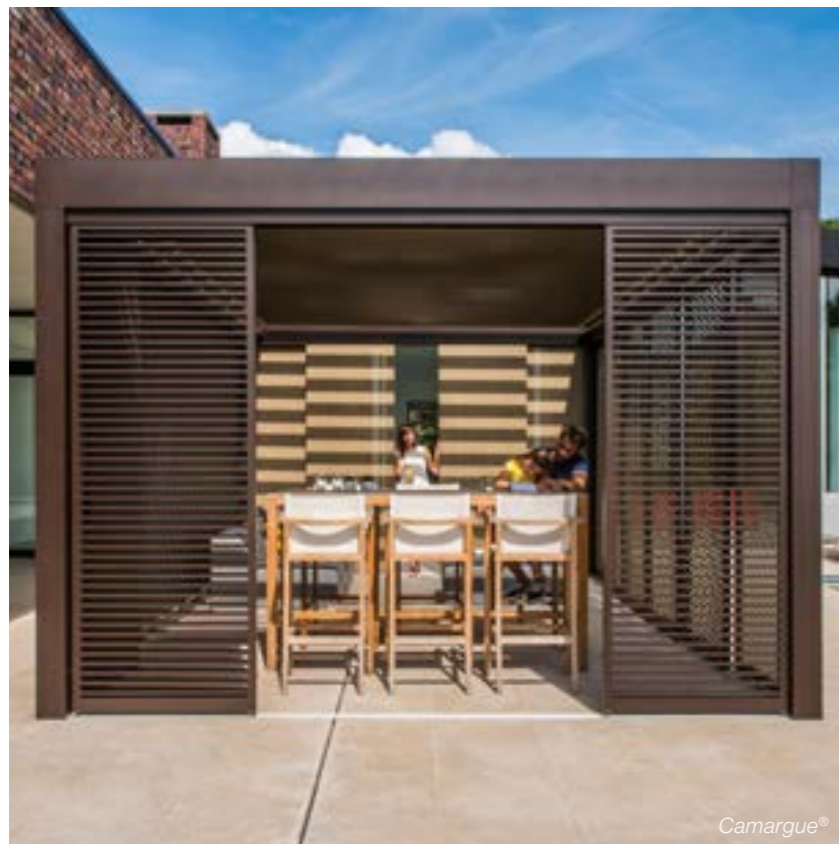

Camargue®

INTEGRATED FIXSCREEN®

(FOR CAMARGUE® LINE AND LAGUNE®)

Perfect integration, even afterwards!

Perfect for:

- Privacy
- Shade when the sun is low in the sky
- Protection from wind, rain, and insects



WARRANTY

Thanks to an ingenious zip system, the screen is windproof in every position and is insect-proof when closed. It is an incredibly well-thought-out principle in which the sun protection fabric has a special zippered trim. This ensures that the entire structure is held firmly in place by the two side channels.

By integrating this Fixscreen, with or without Crystal windows to keep a view of the outside, you can create an extra outdoor room where the users are protected from sun, rain, and wind. These screens come in 50 colours and allow you to customise the **Camargue Line** and **Lagune** and create the atmosphere you desire.

Connect&Go - technology

The integrated Fixscreen is fitted with our patented Connect&Go technology. This new development provides an enormous advantage for installation, as well as for removing the fabric roller tube when replacing a screen or motor.

Custom print

Aside from our standard range, fabrics can also be customised. Options include printing your business logo or printing a photo onto a screen underneath a patio cover.



Camargue®

Bottom bar disappears into the box

The Camargue Line's frame profiles are developed in such a way that the bottom bar is aesthetically hidden away in the box when the screen is raised. Perfect integration, even afterwards!



Bottom bar disappears into the box

* 5-year guarantee on Fixscreen technology for freestanding Fixscreen applications

SURFACE MOUNTED FIXSCREEN®

(FOR ALGARVE® LINE, ELLICE AND LAPURE®)

Enclosing the sides

To close off the sides of the Algarve, Ellice, or Lapure, these can be combined with the Fixscreen 100^{EVO} Slim F or the Fixscreen 150^{EVO} F.

This allows for the box for the sun protection screen to be mounted underneath the frame profiles so that this connects perfectly with the basic construction.



FIBREGLASS FABRIC FIXSCREEN®

(CAMARGUE® LINE, ALGARVE® LINE, ELLICE, LAGUNE® AND LAPURE®)

Transparent sun protection fabric

The best choice in transparent sun protection fabric for windproof vertical sun protection is fibreglass fabric. Fibreglass fabrics score the highest in terms of tension and rigidity, and are also highly resistant to moisture and heat, all while maintaining the view.

We offer a wide range of colours so that you can find the fabric that suits you perfectly.

The Architects' Selection is a range of colours that are very popular in current design and architecture trends.

Our Renson® Ambassadors will be happy to assist you in making your choice.

The fibreglass fabrics are also available with a Crystal window, providing a crystal-clear view.

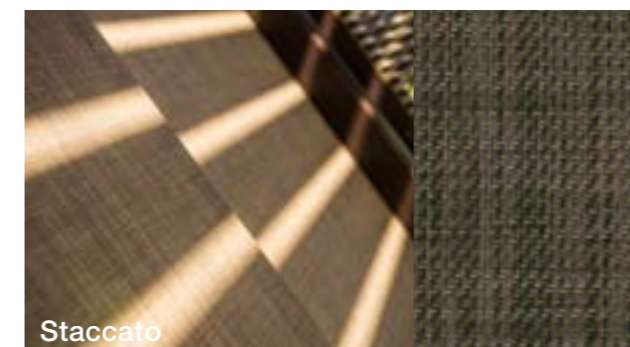
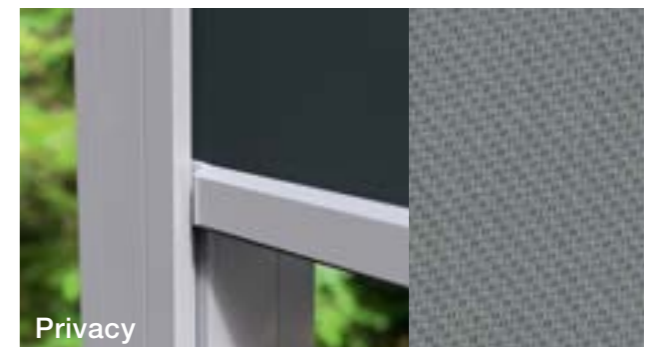
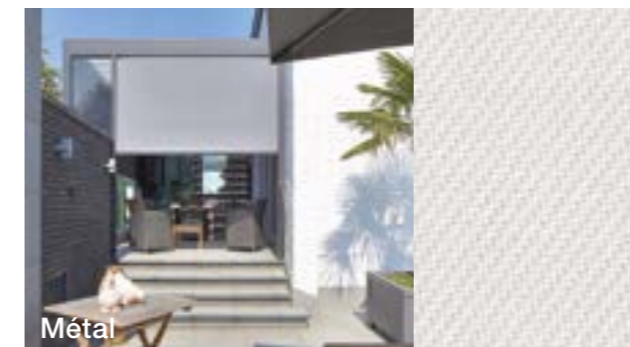

Staccato: only applicable to Loggiascreen Canvas

CRYSTAL SCREEN

Optimum contact with the outdoor space

Transparent Crystal Screens can be fitted in the fibreglass fabric of the Fixscreen to maintain optimal contact with the outdoors. This transparent type of fabric is made from PVC (Fire classification M2).

This transparent crystal screen can be integrated into the fibreglass fabric of Fixscreen 100^{EVO} Slim F, Fixscreen 150^{EVO} F and integrated Fixscreen.

The Crystal screen is always 1200 mm high and extends across the full width of the Fixscreen. A minimum distance of 400 mm applies between the Crystal screen and the top and bottom edge of the Fixscreen.

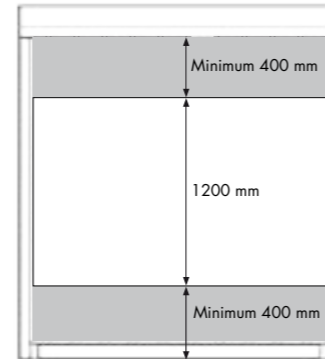

A distance of 800 to 1000 mm from the bottom edge provides the best possible view for people underneath the patio cover.



SOLTIS® PROOF W96 WATERPROOF SCREEN ROOF

(LAPURE® AND LAGUNE®)

Lapure and Lagune roofs are fitted with an innovative, waterproof, transparent sun protection fabric. Both sides of this polyester fabric are coated with a UV-resistant, waterproof coating. This screen is available in various colours.

Soltis® Proof W96



W96-1103 W96-8102 W96-2171 W96-8861 W96-2047



B-SCREEN TENSION CEILING

(ALGARVE® CANVAS & AERO® CANVAS)

The roof of **Algarve Canvas** and **Aero Canvas** is finished with a unique patented tension ceiling. Fibreglass fabric is stretched using the proven Fixscreen technology into the frame for a horizontal, seamless and clean finish of the ceiling without annoying intermediate beams.

B-screen



B3-0202 White B3-0220 White Linen B3-2020 Linen B3-0720 Pearl Linen B3-0207 White Pearl B3-0707 Pearl

B3-3001 Charcoal Grey B3-3030 Charcoal



COLOUR SELECTION ALUMINIUM

Available in all top-100 RAL colours

Our patio covers are powder-coated with 'Seaside quality' pretreatment as standard. The products are available in the 100 RAL colours in architectural textured coatings at no extra cost.

Renson® recommends using architectural textured coatings to get an architectural, contemporary look. In addition, textured coatings are more suitable for outdoor use and will hide any scratches much better.



**ANYTHING
IS POSSIBLE!**
TWO-TONED COLOUR
AT NO EXTRA COST

AUTOMATION

Easy remote operation

You can operate your patio cover easily using Somfy automation. You can operate the roof and/or the screens of your patio cover by remote control. Depending on the desired use and the number of screens, you can choose from several different remote controls.

Thanks to TaHoma, the new Somfy user interface, your patio cover can be controlled from your smartphone, tablet, or computer.

We recommend installing rain and/or wind sensors for an optimum level of comfort.



somfy.



PATIO COVERS

CUSTOMISATION / SIDE ELEMENTS



FAQ

- Weather-resistant 137
- Tests 138
- TIPS & FAQ 140

PERFECT OUTDOOR CLIMATE, DAY AND NIGHT, IN ANY SEASON, THANKS TO RENSON®



WEATHER-RESISTANT

Can be closed to block out rain and wind

Lapure and Lagune are patio covers with waterproof, transparent sun protection screens. The Fixscreen technology combined with optimum screen tension ensures that rainwater is drained off via hidden channels. Even if the sun protection screen is not fully unrolled, the water that falls on it is drained away via this integrated water-drainage system.

Camargue Line, Algarve, and Aero Line are patio covers with rotatable blades in the roof. These patented blades are designed in such a way that the water is drained off to the side even if the blades open up after it rains.



Lagune can drain an amount of water equivalent to rains with an intensity of 180 mm/hr that last up to 2 minutes. These kinds of rains occur on average once every 15 years in Belgium. (See Belgian rain statistics: NBN B 52-011 norm)



Algarve Line can drain an amount of water equivalent to rains with an intensity of between 144 mm/h and 180 mm/h that last up to 2 minutes maximum. These kinds of rains occur on average once every 10 years in Belgium. (See Belgian rain statistics: NBN B 52-011 norm)



The Camargue Line can drain an amount of water equivalent to rains with an intensity of 180 mm/h that last up to 2 minutes maximum. These kinds of rains occur on average once every 15 years in Belgium. (See Belgian rain statistics: NBN B 52-011 norm)



TESTS

Protection and comfort

Our patio covers offer protection and comfort at various levels. To guarantee they can do so, they are thoroughly tested for water resistance, load-bearing capacity and wind resistance.

Water tested

Water resistance and water drainage are tested using a spray installation that mimics rain. For example, we check how much water our patio covers can drain and how this drainage can be optimised:

- Algarve Line and Ellice: The Algarve Line and Ellice can drain an amount of water equivalent to rains with an intensity of 120 l/m²/h for Algarve and 100 l/m²/h for Ellice that last up to 2 minutes maximum. This kind of rain occurs on average once every ten years in Belgium. (See Belgian rain statistics: NBN B 52-011 standard)
- Camargue and Camargue Skye: The Camargue and Camargue Skye can drain an amount of water equivalent to rains with an intensity of 150 l/m²/

that lasts up to 2 minutes maximum. This kind of rain occurs on average once every 15 years in Belgium. (See Belgian rain statistics: NBN B 52-011 standard)

- Lagune: The Lagune can drain an amount of water equivalent to rains with an intensity of 150 l/m²/h that lasts up to 2 minutes maximum. This kind of rain occurs on average once every 15 years in Belgium. (See Belgian rain statistics: NBN B 52-011 standard)
- Lapure: The Lapure can drain an amount of water equivalent to rains with an intensity of 50 l/m²/h that lasts up to 2 minutes maximum. In heavy rainfall, water can flow over the bottom bar.

without any permanent deformation occurring.

The load-bearing capacity of Algarve and Camargue is dependent on the basic structure and the surface area. The diagram indicates the load-bearing capacity of our patio covers depending on their Span and Pivot dimensions.

In concrete terms: A patio cover with a Pivot of 6000 mm and a Span of 4000 mm may bend by 30 mm under a load of 55 kg/m² (i.e. 1320 kg across the entire patio cover). Another example: a patio cover with a 3375 mm Span and a 5835 mm Pivot can bear a load of no less than 110 kg/m² (i.e. 2160 kg!).

External testing done on the Camargue shows that it can hold up at 200 kg/m², even at its largest dimensions.

Load-bearing capacity

Patio covers are subjected to various external forces (e.g. snow). The load-bearing capacity of our patio covers is determined using static strength calculations carried out by our engineers and validated through internal tests. The basic principle is that the structure is allowed to bend by 1/200th of its longest dimen-



200 Kg/m²

Wind tests

In order to determine the wind forces that our patio covers and vertical sun protection screens can withstand, wind tunnel tests were carried out.



Miami-Dade Hurricane-resistant

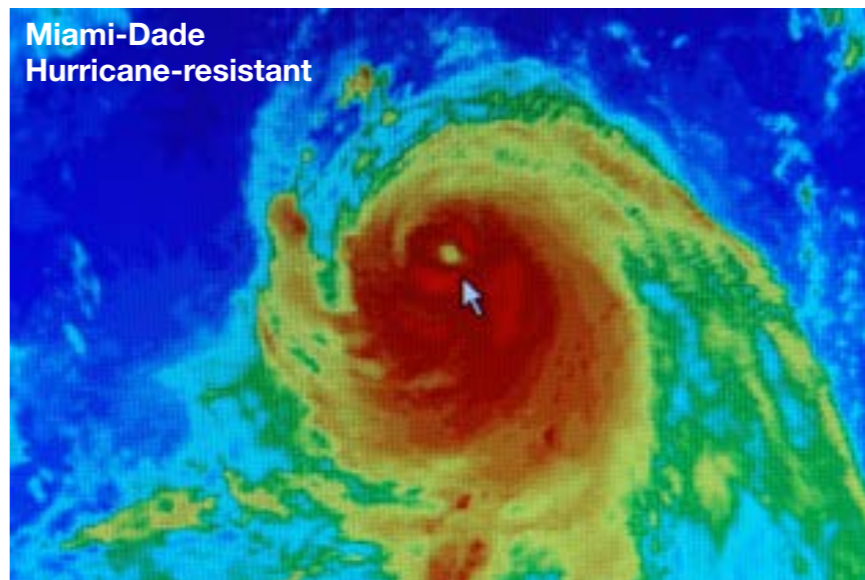

Beaufort scale



Beaufort	Description	Average speed in m/s	Average speed in km/h	Results
0	Calm	< 0,2	< 1	You don't feel the wind. Smoke will rise virtually straight up.
1	Light air	0,3 - 1,4	1 - 5	Wind direction can be read from the smoke plume, but not from the weather vane.
2	Light breeze	1,5 - 3,4	6 - 12	Wind can be felt on the face, leaves rustle, the weather vane moves visibly with the wind.
3	Gentle breeze	3,5 - 5,4	13 - 19	Flags wave and leaves move about constantly.
4	Moderate breeze	5,5 - 7,4	20 - 27	Dust blown up irritates eyes. Hair is awry.
5	Fresh breeze	7,5 - 10,4	28 - 37	Bushes rustle, white tops on lakes and canals.
6	Strong breeze	10,5 - 13,4	38 - 48	Umbrellas are difficult to hold on to, large branches sway, power lines hum
7	High wind, moderate gale, near gale	13,5 - 17,4	49 - 62	It is difficult to walk into the wind. Trees sway.
8	Gale, fresh gale	17,5 - 20,4	63 - 73	Making headway is very difficult. Small branches break off.
9	Strong/severe gale	20,5 - 24,4	74 - 87	Chimney tops, roofing tiles and antennas blow away.
10	Storm, whole gale	24,5 - 28,4	88 - 102	Adults blow over. Major damage to buildings.
11	Violent storm	28,5 - 32,4	103 - 117	Major damage to houses and forests.
12	Hurricane force	> 32,5	> 118	Total destruction.

TIPS

Column positions

Camargue Line, Algarve Line and **Lapure** can also be ordered with 'shifted' columns. To give just one example, this can be useful if the patio cover needs to extend beyond the terrace (but the columns need to remain on the terrace), to ensure enough shade is provided even when the sun is low in the sky.

You can also choose shifted columns for placement or architectural reasons. The column can be shifted a maximum of 1/5th of the total Pivot length.

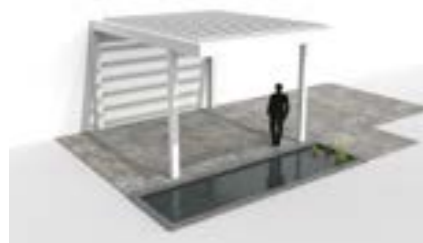

Blade rotation direction

The direction of rotation of your blades is important for the **Camargue Line, Algarve Line** and **Aero Line**. Do you want to be able to protect against sunlight for as long as possible or allow sunlight to flow in as quickly as possible?

You can make this choice with Renson®. When adding a patio cover to a kitchen or a living room, for example, people usually want light to get in as quickly as possible.

- ① The blades rotate as standard, to the extent that the southern sunlight is blocked when opening the blades. Sunlight can also be allowed in with standard sun protection blades by rotating them further.

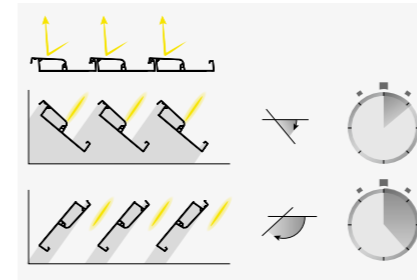

- ② When the blades are slightly turned in, the blades will move into the correct angle more quickly and the smooth, lovely underside remains visible.

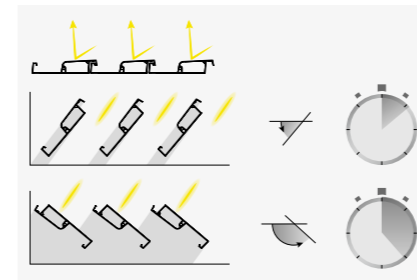

Blade colour

Camargue Line, Algarve Line and **Aero Line** are available in bicolour (i.e. with roof blades in a different Top 100 colour than the frame and columns) at no extra cost.

Tip: if your structure has a dark colour, select a lighter colour for the blades. A darker roof blade colour creates the impression of a lower ceiling. A lighter colour creates a sense of more space and has additional sun and heat protection properties.



Veranda

Is a patio cover like the **Camargue Line** or **Algarve Line** similar to a veranda?

No! A veranda is an extension of the living space enclosed in glass and creates an enclosed space that is completely wind and waterproof. In contrast, a patio cover is an open aluminium structure with a roof of rotatable, aluminium blades that (possibly combined with side panels) primarily offers shelter from the sun and, to a certain extent, bad weather. The climate under a patio cover is essentially that of the outdoors, allowing users to enjoy the ambience, scents, colours, and sounds of the garden.

Condensation can be formed on the bottom of the blades in cold weather.

Therefore, it is best to place weather-proof garden furniture under a **Camargue Line** or **Algarve Line**.

Wind - Camargue Line and Algarve Line

If high winds are forecast, we recommend closing the louvered roof (possible with wind speeds of up to 50 km/hr). Closing the louvered roof makes the entire structure more rigid, meaning it can withstand high winds much better. We also offer a warranty on our **Camargue Line** and **Algarve Line** with the roof closed for wind speeds of up to 160 km/h for the Camargue, 120 km/h for the Algarve, and 100 km/h for the Ellice!

Screen or blades

How can I choose between a patio cover with a louvered roof (**Camargue Line, Algarve Line and Ellice**) or with a screen roof (**Lapure and Lagune**)?

Each type of patio cover has its own advantages. A patio cover with a sun protection screen can be opened up completely. This allows you to keep sunlight out or allow it to enter across the full extent of the roof, depending on the weather conditions. Patio covers with roof blades allow users to control the amount of sunlight based on their requirements; when there is too much sunlight, the blades can be closed completely, but the roof can never be opened up completely to maximise the amount of sunlight.



	Louvered roof	Screen roof
Roof	Horizontal	Always at an angle
Position	Constructed, recessed or freestanding	Only constructed
View of 'open' roof	Roof blades rotate open but don't 'disappear'	'Roof' completely disappears
Light with a 'closed' roof	Opaque (except Lineo Luce blades)	Transparent
Load-bearing capacity	Can bear snow	Cannot bear snow
Colour of the roof	All possible colours	Limited range of colours available for fabric screen roof

Low sun: Fixscreen

When the sun is low in the sky, sunlight can come in underneath the patio cover and into your home. This is a great way to warm your house up naturally in winter. However, this sunlight can be disruptive at times and may cause temporary blinding, colour fading or reflections on TV and computer screens. Incoming sunlight can be reduced using a vertical sun protection screen (Fixscreen) in the sides of your patio cover (**Camargue Line** and **Lagune**). As the fabric used in Fixscreens is transparent, your outside view is maintained.



Passage height

You are free to choose the passage height of your louvered roof (**Camargue Line, Algarve Line and Ellice**). People usually choose a height based on their specific circumstances (for example, with a façade-mounted structure, there might be a roof gutter or window in the way) or for personal reasons; tall people might prefer a higher passage height to create a certain amount of 'openness'. On the other hand, it is best to have the lowest possible passage height for the most shade.



Orientation of the terrace

Depending on the orientation of your terrace, you can decide to position your covering differently. Patio covers with a screen (**Lagune** and **Lapure**) or adjustable blades (**Camargue Line** and **Algarve Line**) are both good solutions for a south-facing terrace. You can keep the heat of the sun at bay by rolling out the fabric or closing the blades. It is best to install the blades of a louvered roof parallel to the home. This gives you maximum control over the amount of sunlight that enters: you can choose to keep the light out entirely or partially or allow it to flood in.

For a north-facing terrace, installing the blades perpendicular to the wall is a good idea. This is the best way to control the light coming in from the east and west, while allowing the maximum amount of light to enter with the roof open.

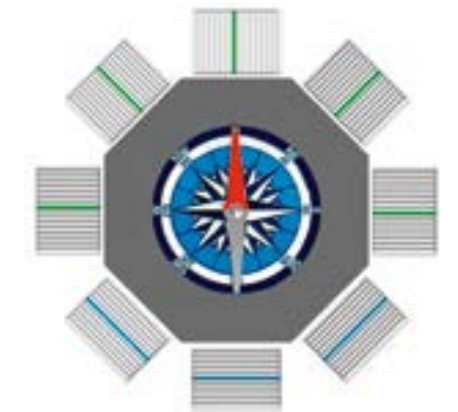

■ E-NE-N-NW-W: blades perpendicular to the wall.
■ SW-S-SE: blades parallel to the wall.

THE MOST FREQUENTLY ASKED QUESTIONS ABOUT RENSON® PATIO COVERS...

Can a Renson® covering be made to measure?

All Renson® patio covers are custom-made to within a millimetre, at no extra cost. The Ellice is the only covering where one side size is dependent on the number of blades.

What are the maximum dimensions?

This depends on the type of covering. Please consult the product table in this brochure. This table shows the possible dimensions of one roof module. Modules can be coupled to obtain larger dimensions.

Which colours are possible?

The top 100 RAL colours are available in architectural textured coating at no extra cost. This allows you to match the colour of your covering to the carpentry of your home. The blades can be chosen in a top 100 RAL colour other than the architectural textured coating at no extra cost. Ellice is only available in 20 architectural textured coatings.

Does the covering always have to be placed against a wall or can it also be freestanding?

Patio covers with louvered roofs (Camargue line, Algarve line, and Ellice) can be installed either as freestanding or fitted against a construction. The patio covers under the incline, with screen or fabric roof, can only be built against a house or other construction. The Aero roofs are specially designed to be built into a new or existing support structure.

Don't the blades in the roof take away too much light?

You have full control over the intensity of the light with blades.

When closed, you have no light transmission or you can optionally install some glass or LED blades for more light.

When the blades are slightly rotated, you get a lot of light inside quickly. With the Camargue Skye, you can not only rotate, but also slide the blades to one side. This gives you a completely open roof.

Is a louvered roof completely waterproof?

In addition to sun protection, louvered roofs and fixed screen roofs also offer complete protection from the rain. However, you should bear in mind that a patio cover is an open aluminium structure, not to be confused with a veranda. Furniture and floors must therefore be suitable for outdoor use.

What options are available in a covering?

The Renson® patio covers can be equipped with a wide range of accessories and thus perfectly configured to your personal taste. (Fixscreen sun protection, Loggia sliding panels, glass sliding panels, lighting, heating, music, etc.)

Can I also enjoy my roof outside the summer season?

This is certainly possible. The best way to do this is to equip the roof with the appropriate sides (Fixscreen, Loggia, or glass sliding panels). Lighting and heating are also among the possibilities to enjoy in all seasons all year round.

How should I clean the covering?









Your Renson® covering will be fully exposed to the elements for many years. If you want to enjoy it optimally at all times, we recommend annual cleaning with the **Renson Maintenance Set** products. This maintenance set products will ensure that the intense colour is maintained for years, as well as providing extra protection from acid rain, sea air, and UV rays (see also the increased warranty for yearly use).

Does a covering increase the value of my house or property?

Of course. Official estimates of homes with a Renson® roof also include this in the valuation of the property. Investing in a Renson® covering is therefore an immediate way to increase the value of your home!

Doesn't it get too hot under a louvered roof?

A louvered roof is not only protection from the sun; it is ventilating as well. If the air under the covering warms up too much, a ventilation effect can be created by simply rotating the blades slightly, so that the warm air flows away through the roof.

TYPE	HORIZONTAL DESIGN				HORIZONTAL DESIGN			INCLINED DESIGN		
	CAMARGUE® LINE		ALGARVE® LINE		ELLICE®	AERO® LINE		LAGUNE®	LAPURE®	
	Camargue®	Camargue Skye®	Algarve®	Algarve Canvas®	Ellice®	Aero®	Aero® Canvas®	Lagune®	Lapure®	
										
ROOF OPTIONS	Rotatable blades	Rotatable and retractable blades	Rotatable blades	Fixed roof	Rotatable blades	Rotatable blades	Fixed roof	Retractable, waterproof, translucent sun protection screen	Retractable, waterproof, translucent sun protection screen	
DIMENSIONS										
Max. width / pivot	6200 mm		6055 mm		6050 mm	6055 mm	6055 mm	6000 mm	6000 mm**	
Max. depth / span	4500 mm		4500 / 6000 mm*		4500 mm	4500 mm	4500 mm	6200 mm	5000 mm	
Max. passage height	2800 mm		2800 mm		2800 mm	-	-	2500 mm	2900 mm	
Joinable	multi-part joinable		two-part joinable		-	two-part joinable	two-part joinable	up to a max. width of 12 m	up to a max. width of 18 m	
Min. incline	no incline (0°)		no incline (0°)		no incline (0°)			8°	10°	
Max. blade rotation	150°	145°	150°	-	150°	150°	-	-	-	
ACCESSORIES										
SIDE ELEMENTS	Integrated Fixscreen	option	option	-	-	-	-	-	option	-
	Surface-mounted Fixscreen	-	-	option	option	option	-	-	-	option
	Loggia sliding panels	option	option	option	option	-	-	-	option	-
	Loggiascreen Canvas sliding door	option	option	-	-	-	-	-	option	option
	Glass walls	option	option	option	option	-	-	-	option	-
	Linus/Linarte wall passage height	option	option	option	option	-	-	-	-	-
	Linus/Linarte wall as railing	option	option	option	option	-	-	-	-	-
	Triangle	-	-	-	-	-	-	-	option	option
	Outdoor curtains	option	option	option	option	-	-	-	-	-
	Extra column	option	option	option	option	-	-	-	option	option
Shifted column	option	option	option	option	-	-	-	-	option	
Adjustable wall profile	option	option	-	-	-	-	-	-	-	
LIGHTING	Lineo LED	option	-	option	-	option	option	-	-	-
	UpDown LED	option	option	option	option	-	option	option	-	-
	Colomno LED	option	option	-	-	-	-	-	-	-
	Lapure LED	-	-	-	-	-	-	-	-	option
	Lagune LED	-	-	-	-	-	-	-	option	-
COMFORT & DESIGN	Beam Heat & Sound	option	option	option	-	-	option	-	option	-
	Translucent blades Lineo Luce	option	-	option	-	-	option	-	-	-
	Wooddesign	option	option	option	-	-	option	-	-	-

* > 4500 mm is possible when expanded, up to max. 6000 mm

** up to 4000 mm without cross-beam, > 4000 mm to 6000 mm with cross-beam

You will find all information about the possible options and technical specifications in our technical catalogue, which you can find in the showroom of your local Renson dealer. For all distribution points, see www.renson-outdoor.com

”
A STYLE
ALL AROUND
YOUR HOUSE
“

We were still looking for a patio cover with a louvered roof and a carport in the same style to match our newly built home. We found the ideal solution with Algarve and Algarve Canvas from the Algarve Line. The elegant structure fits in beautifully with our sleek architecture and meets our needs perfectly. Our car can now be parked under the shelter of an Algarve Canvas and the value of our home has increased considerably. We used Algarve to create the ideal climate on our terrace and we have a structural solution that protects us from sun, rain, wind, and cold thanks to the adjustable louvered roof, the sun screens, and the stylish heating system.



Algarve® Canvas



Algarve® Canvas

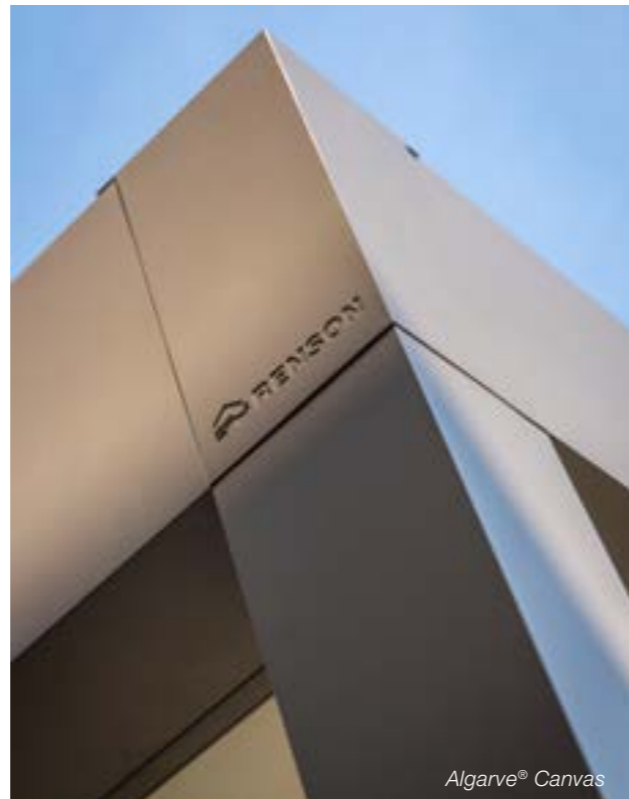

Algarve® Canvas



CARPORTS

ALGARVE® CANVAS

Algarve® Canvas



ALGARVE CANVAS®

This elegant carport offers lasting protection by means of a fixed roof made up of 2 layers: a solid top roof made of white lacquered, profiled steel sheet with anti-condensation coating and an aesthetic lower roof, finished with a stretched canvas with zip technology. The screen is tautly stretched in the structure, without any visible additional beams. It is available in 8 colours. Algarve Canvas is just as useful as a fixed patio cover, carport or as an awning above the front door, for instance. In addition, a combination of an Algarve with rotatable louvered roof and an Algarve Canvas with fixed roof structure is possible to create a single, uniform style around the house.



Roof section



Water drainage



INSTALLATION OPTIONS

Types of installation



Algarve Canvas – Freestanding

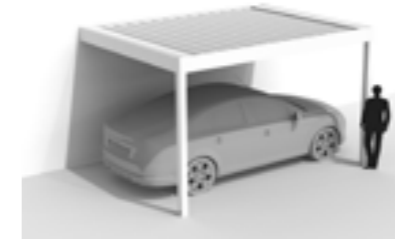

Algarve Canvas – Façade mounting

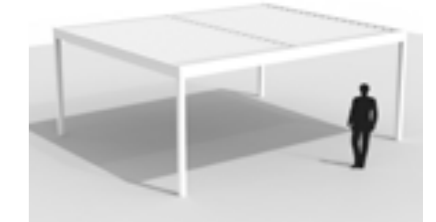

Algarve Canvas – 2-part coupling on the Span side

Personalization possibilities

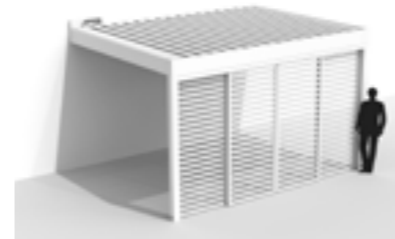

Loggia

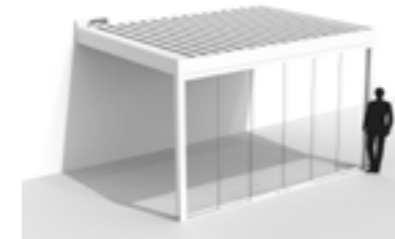

Glass sliding panels

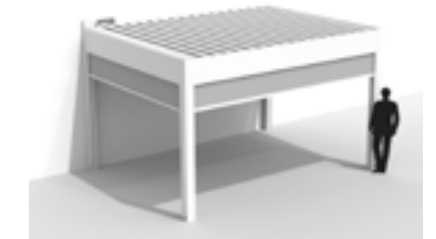

Surface-mounted Fixscreen

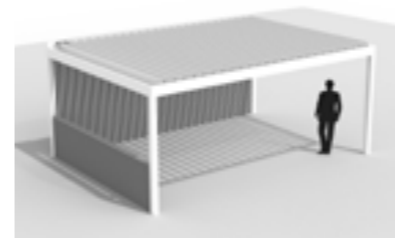

Linius fixed wall

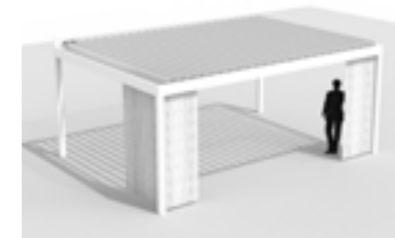

Curtains

Fixscreen® 100^{EVO} Slim F / Fixscreen® 150^{EVO} F - Algarve® Line

To close off the sides of the Algarve Line, it can be combined with the Fixscreen 100^{EVO} Slim F and the Fixscreen 150^{EVO} F. This allows the box for the sun protection screen to be mounted underneath the frame profiles so that this connects perfectly with the basic construction.



FAÇADE ELEMENTS



FAÇADE ELEMENTS

Intro

- Why choose Renson façade elements? 163
- Façade, outdoor, indoor 164

Linarte

166

- Overview of the range 168
- Inserts 170

Linus

172

- Overview of the range 174
- Finger-trapping protection system 175

Loggia Sliding panels

176

- Overview of the range 178
- Flexguide 179

THE ULTIMATE COMBINATION OF QUALITY AND DESIGN

Renson® pays a great deal of attention to the design, customisation, and quality of the finish when developing its façade elements.

You create your façade elements according to your own taste. Horizontal or vertical, they can be integrated into a wide variety of styles: from classic to modern to contemporary. This way, you create a unique, stylish, elegant, and contemporary look for your home or business.

Garage gates and doors blend seamlessly into one tight façade surface. Functional elements such as letter boxes, intercoms, or doorbells are seamlessly integrated. The high-quality finish makes them suitable for interior applications as well.

Of course, simple and flexible assembly is paramount. Invisible fixations provide a sleek design and allow thermal expansion at the same time.

Renson® is committed to durability, as is the case with these aluminium façade elements. It is not only wear-resistant, but also resistant to all weather conditions. Lightweight yet strong... and above all: extremely easy to maintain.

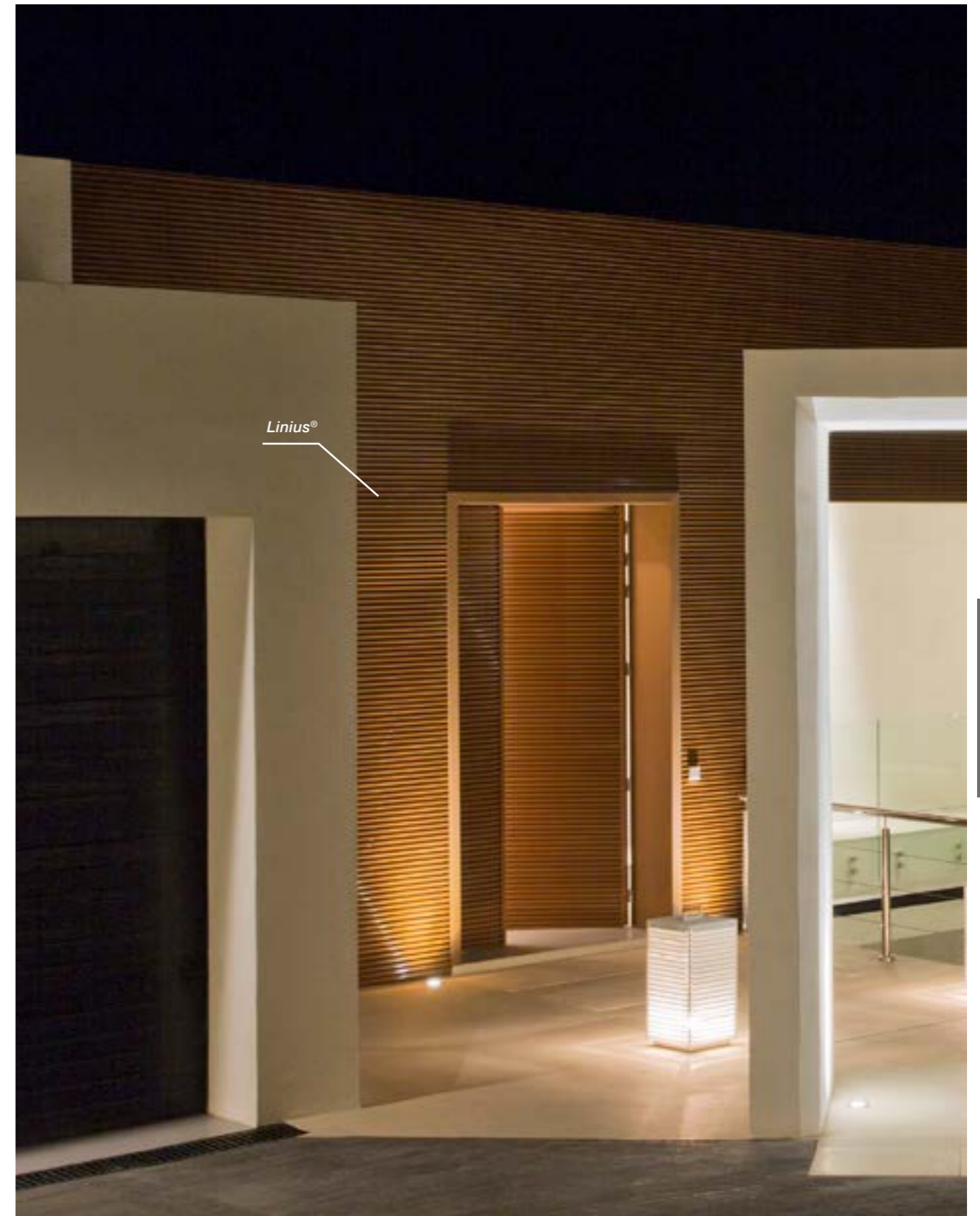



Loggia® Sliding panels

WHY CHOOSE RENSON® FAÇADE ELEMENTS?



Durable quality

Thanks to the construction of aluminium profiles, you can be sure of durable and sturdy façade elements that are resistant to the most extreme weather conditions. Furthermore, aluminium façade elements are also an environmentally conscious choice because aluminium has acquired the reputation of green metal through its 100% and infinite recyclability.



Sleek design

Are you looking to add a special touch to your home, shop, or company building? With Linius and Linarte façade elements, you are guaranteed to be successful. Horizontal or vertical, in practically any colour, for both indoor and outdoor, and even a seamless finish for curved façades or around corners. Thanks to the invisible fixations, you can show off an incredible result.



Endlessly customisable

A subtle design or a clear statement: get creative with the possibilities to customise your façade: different inserts with wood or LED lighting, combine colours, or integrate your house number or company logo into the façade. External sockets, intercoms, letter boxes, or external faucets are subtly integrated.



Maintenance-friendly

Aluminium façade elements require hardly any maintenance. The powder-coated profiles retain their colour in all circumstances and are easy to clean.

FAÇADE, OUTDOOR, INDOOR

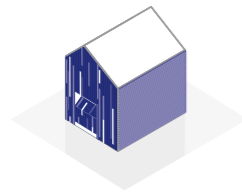

Beautiful façade elements

Linus or Linarte give an extra accent to an outside wall and can be perfectly combined with other materials for a unique look & feel that can also be extended into the interior (see below). Looking for a unique façade? Let your creativity run free with Linarte wood inserts or LED strips.

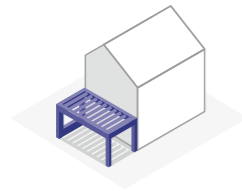

Patio cover in the same look&feel

If you're searching for aesthetic uniformity, you can even extend the façade elements to your terrace. One or multiple sides can be closed off in the same finish under a patio cover. One style for your entire home or building... it guarantees a sleek and uniform look.

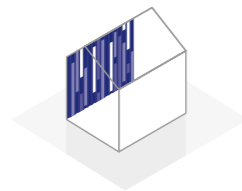

Unique interior

The Renson® aluminium façade elements can just as well be used inside as outside to give an extra touch to a wall. You can even let both seamlessly merge with each other. The high-quality materials make it perfectly possible to use, e.g. Linarte profiles to clad a stairwell.



LINARTE



With the Linarte profiles, façades or façade components can be finished to create a sleek whole with vertical profiles in different designs: both inside and outside, right down to under the patio covers. Gates and doors can also be covered with the same profiles to create a seamless and uniform whole. The continuous façade system consists of individual aluminium profiles that are available in different versions and which can be endlessly customised with wood or LED strip inserts.



Linarte®



Linarte®

FAÇADE
ELEMENTS

LINARTE®

“Thanks to the simple click system, there are a lot of possibilities”

LINARTE BLOCK 16

The basic version of the Linarte block-shaped aluminium profiles are 16 mm deep. This limited depth creates a subtle vertical line pattern with limited relief and minimalist look.

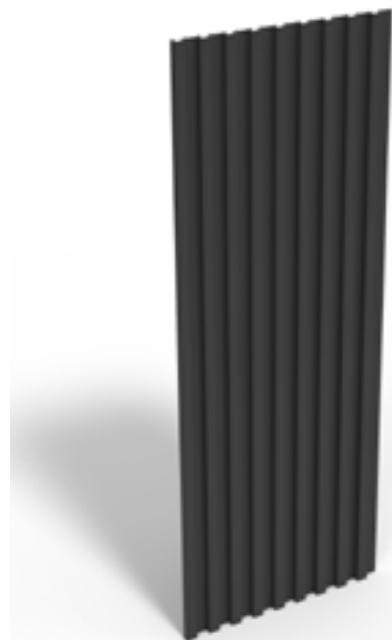
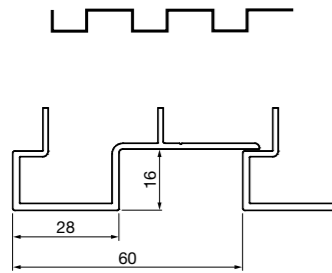

LINARTE BLOCK 30

The block-shaped Linarte profile with a depth of 30 mm creates a strong vertical line pattern. This results in striking shadow effects that bring a façade to life. These deep block profiles can be combined with inserts in wood or LED strips.

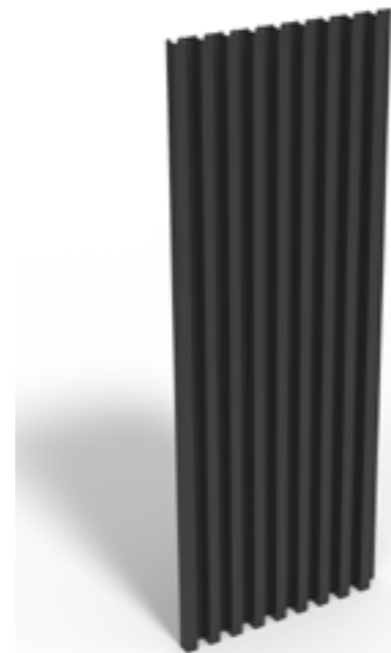
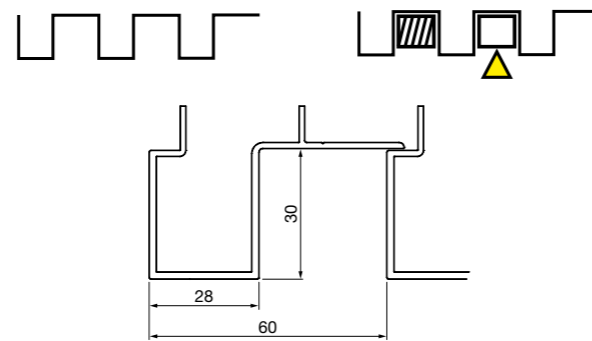

LINARTE EVEN

The rib-shaped Even profile of 30 mm deep provides the sleekest Linarte result and emphasises the vertical lines of a façade to the utmost. These profiles can also be combined with inserts in wood or LED strips.

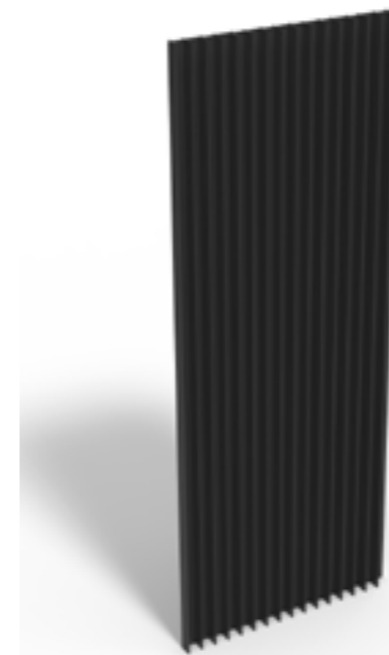
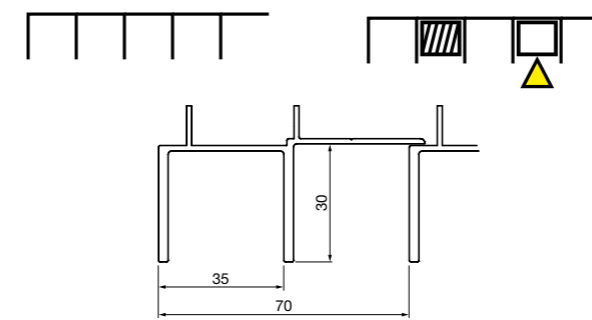

LINARTE RANDOM

Block or Even, all Linarte profiles can be combined. Let your creativity run free, create a unique play of shadow and light, and combine your façade with a personal character to your heart's content.

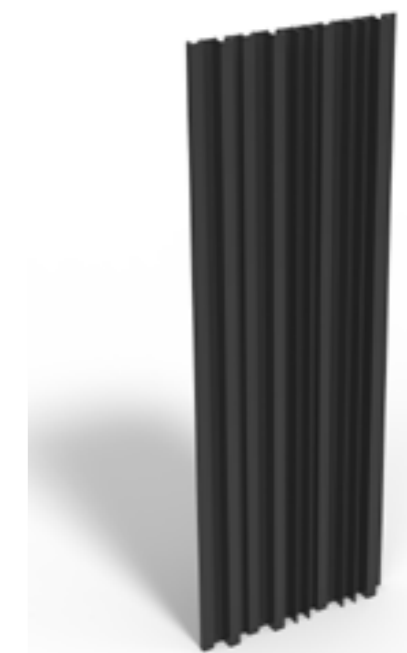
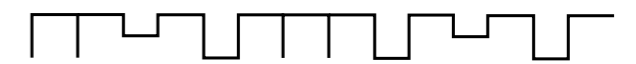

WOOD INSERTS OR LED STRIPS

Wood or LED strips can be incorporated into both the 30 mm deep Block and the Even profiles. These inserts are available in various lengths and can be integrated anywhere in the façade: randomly, in a sleek line, or repetitively. It gives you 1001 possibilities to finish to taste. Even logos or house numbers (in wood) can be integrated.



LINIUS

The Linius system can be used to finish façades or façade components into a sleek whole with a pronounced horizontal accent. Gates and doors can also be covered with the same profiles. This way, you get a close fit with the rest of the façade to achieve a uniform whole. The continuous bladed wall system consists of individual aluminium profiles that are available in different versions. Depending on the application, you can choose between fully closed or ventilated systems.



Linius®



Linius®



Linius®

FAÇADE
ELEMENTS

LINIUS®

LINIUS L.033

The Z-shaped Linius L.033 profiles are 20 mm deep. They give your façade a strong horizontal accent, sober and refined, with or without a ventilating function.

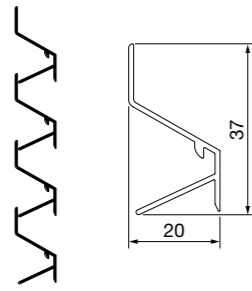

L.033 CL

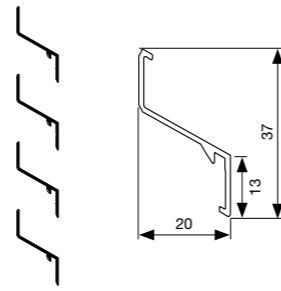

L.033.01
ventilating

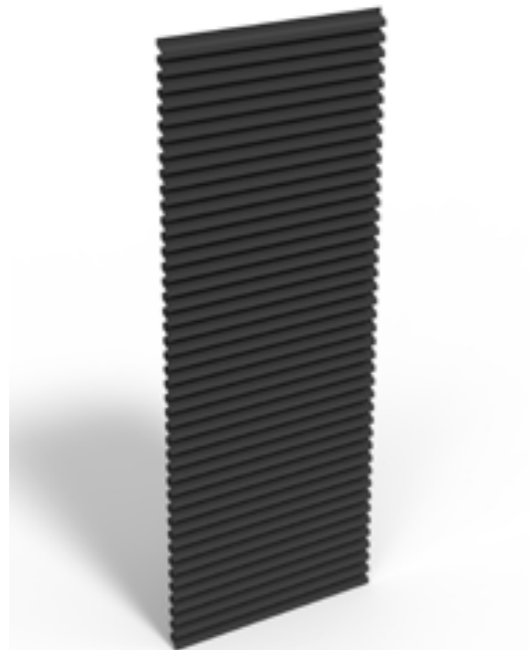

OUR TECHNOLOGIES

Linus finger-trapping protection system

Renson® has developed a special, patented mechanism for sectional gates that ensures that fingers do not get trapped. When a finger accidentally comes between two sections of the gate, the aluminium profile turns away. Once the finger is removed, the profile returns to its original position on its own.

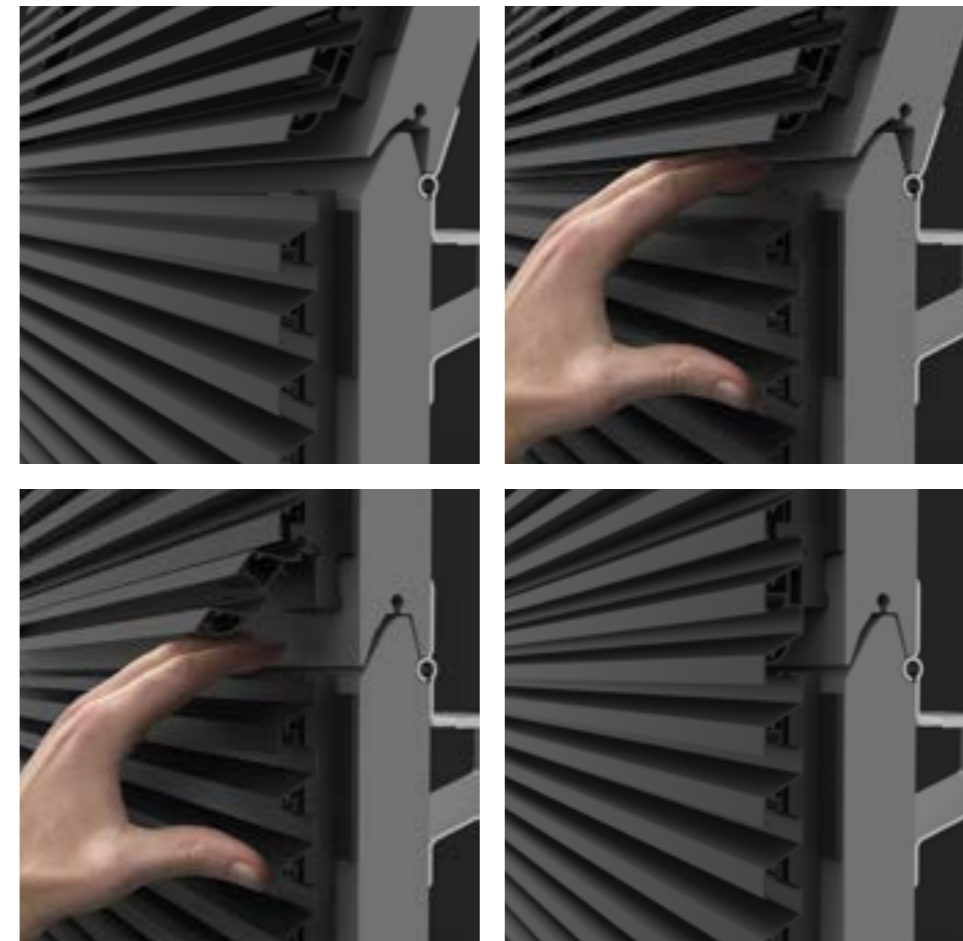

LOGGIA SLIDING PANELS



The Loggia sliding panels combine the functionality of an efficient sun screen panel with the elegant look and aesthetic design within a high-quality and contemporary concept. With the vertical sun screen sliding panels, the home owner can even influence the way sunlight enters rooms (i.e. dynamic sun protection).



FAÇADE
ELEMENTS

LOGGIA® SLIDING PANELS

LOGGIA

The Loggia panels are constructed from aluminium frames finished with screens, and aluminium or wooden blades. It is also possible to opt for movable aluminium or wood blades (Privacy), which can be manually rotated from the closed position to the fully open position, or vice versa.

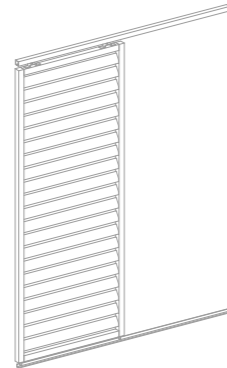

FLEXGUIDE®

The Flexguide is a self-regulating lower channel that uses spring tension to adjust itself to height differences with respect to inclines for terrace water drainage systems, construction tolerance, thermal dilatation, etc. It eliminates the need to place filling material under the lower channel profile to level out slopes (up to 50 mm). The Flexguide spring-loaded pin must always remain in contact with the lower channel profile.

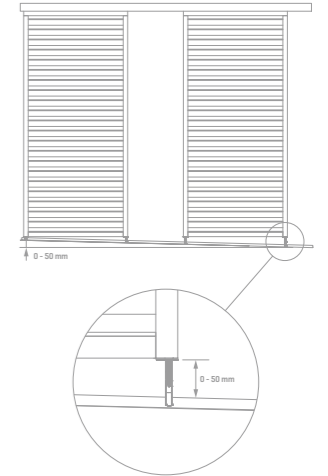

Loggialu Loggialu Plano Loggiawood Loggialu Privacy (moving blades) Loggiawood Privacy (moving blades) Loggiascreen Canvas Loggialu Wooddesign Loggialu Stirata Loggiawood Linea



Specifically for patio covers

Privacy
Inserts with rotatable wooden or aluminium blades

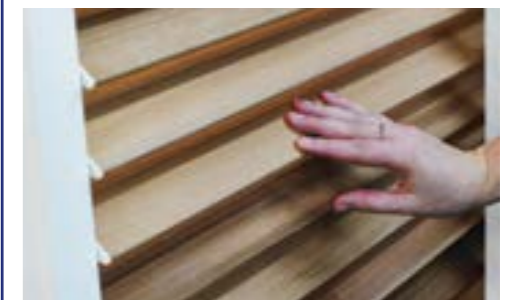

Thanks to our total Outdoor Concept, you can not only extend the minimalist design of the Linarte cladding to your patio cover, but also create a unique look throughout your garden with the Linarte lighting, Sit & Plant Units, and the freestanding Icon wall.

GARDEN ELEMENTS





GARDEN ELEMENTS

Lighting

- Linarte Outdoor Light S 185
- Linarte Outdoor Light M 185

Seating & planter unit

- Linarte Modulo 55 186
- Linarte Modulo 97 186
- Linarte Modulo Combination 187

Freestanding wall

- Linarte Icon 188

eSafe parcel letter box

- Fenix Top Small 190
- Fenix Top Medium 190
- Fenix Top Large 190



LINARTE OUTDOOR LIGHT

Linarte Outdoor Light is available in 20 RAL colours.
 The lighting is not dimmable.
 Linarte Even is available in 2 heights with different options:

Overview

Linarte Outdoor Light Small



Single plug socket



Single lamp



Double lamp
Front & back



Lamp with plug socket

Height 325 mm
 Depth 120 mm
 Width 82 mm

Linarte Outdoor Light Medium



Single plug socket



Single lamp



Double lamp
Front & back



Lamp with plug socket

Height 515 mm
 Depth 120 mm
 Width 82 mm

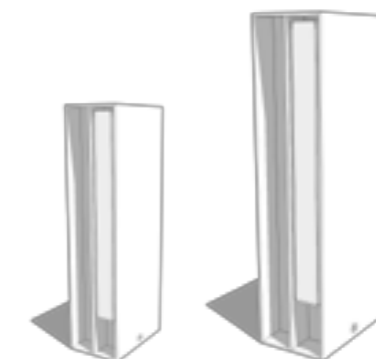

LINARTE MODULO SYSTEM

Linarte Block 30 & Linarte Even. Seating element or planter edge in padauk. Optional with lighting at the bottom. LED option. Available in 100 RAL colours

Overview



Linarte Modulo 55 SIT



Linarte Modulo 97 SIT



Linarte Modulo 55 PLANT



Linarte Modulo 97 PLANT

Height 450 mm
Length 554 mm
Width 554 mm

Height 450 mm
Length 974 mm
Width 554 mm

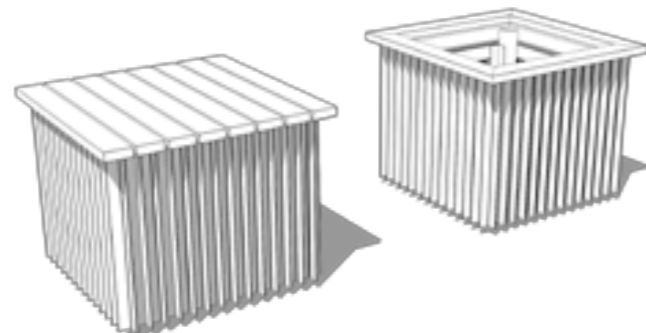

Linarte Modulo COMBINATION

Height 450 mm
Length adjustable
Width 554 mm



LINARTE ICON FREESTANDING WALL

Linarte Icon adds an extra dimension to the garden. This architectural wall is available in a height and width according to your wishes, so the possibilities are endless: from a low garden wall, to a privacy wall, to spatial dividers that visually expand the garden.

The vertical Linarte lines with Block 30 or Even blades form a seamless whole over the entire wall. In addition, one of the two sides can also be fitted with a stretched fibreglass fabric of your choice, which brings the warm feeling of textiles into the outdoor space. Material and colour can be matched to the outdoor furniture if required. You get extra atmosphere by adding Linarte Leds or wood inserts or by integrating an indirect lighting at the bottom of the wall that spreads a beautiful glow. Painted in any colour of your choice, the Linarte Icon in combination with the Linarte façade elements, seating elements, lighting and Linarte wall in Camargue forms a coherent whole around the house and throughout the garden.



Sleek design

- Create a uniform look and feel with your façade cladding throughout your garden with the Renson Outdoor Concept range.

Customisable

- Combination of Linarte profiles, canvas or single-sided finish.
- RAL colour of your choice.
- Cedar inserts or LED strips.
- Indirect lighting.

Durable quality

- Posts in 4-mm-thick steel
- Finishing in high-quality aluminium, weatherproof and recyclable.

Maintenance friendly

- Colourfast, easy to clean.

Dimensions

- Width: min. 1260 mm
- Height: min. 400 – max. 2000 mm
- Thickness: min. 150 – max. 195 mm
- Distance between 2 posts: max. 1200 mm
- Depth for concrete: 750 mm

ESAFE PARCEL LETTER BOXES

Provide your driveway/façade with an eSafe parcel letter box and receive your parcels at home 24/7 a lot easier!

The Fenix Top parcel letter box is made of sturdy 5-mm aluminium. The range includes 3 models, Fenix Top S, M and L. Parcels and letters are deposited in the parcel letter box at the top, resulting in an optimal use of the available volume and a soothing qualitative design. In contrast to the S and M model, the L model is equipped with an extra vertical letter box flap and removable double bottom. The S and M models are equipped with a delayed closing mechanism and shock-absorbing foam to catch the parcels.



Fenix Top Small

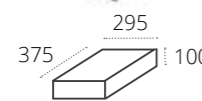

Fenix Top Medium

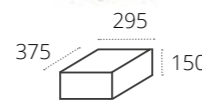

Fenix Top Large

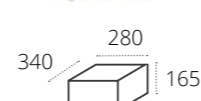

Parcel dimensions:



WARRANTY*



	Structural elements	Motors and electronic controls	Coating gloss and colour	Coating adhesion	Fixscreen® technology (zips)	Crystal belt
Camargue®	10 years	2 years	5 years / 15 years*	10 years**	5 years	2 years
Camargue® Skye	5 years - 10 years***	2 years	5 years / 15 years*	10 years**	5 years	2 years
Algarve® Line	7 years	2 years	5 years / 15 years*	10 years**	5 years	2 years
Ellice®	5 years	2 years	5 years / 15 years*	10 years**	5 years	2 years
Aero® Line	7 years	2 years	5 years / 15 years*	10 years**	5 years	2 years
Lagune®	5 years	2 years	5 years / 15 years*	10 years**	5 years	2 years
Lapure®	5 years	2 years	5 years / 15 years*	10 years**	5 years	2 years
Façade elements	5 years	2 years	5 years / 15 years*	10 years**	-	-
Garden elements	5 years	2 years	5 years / 15 years*	10 years**	-	-

* Subject to registration and annual maintenance using the Renson® Maintenance Set

** In areas < 500 m from a coastline: 5-year warranty on adhesion

*** 10-year warranty on the load-bearing structure and 5-year warranty on the mechanical parts

MAINTENANCE

Easy maintenance using the Renson Maintenance Set

Your patio cover will be fully exposed to the elements for many years. To ensure you can make the most of your Renson® patio cover at all times, we recommend regular maintenance, i.e. once or twice a year. Regular maintenance will extend the lifespan of your covering. The following are important:

- The structure is made using powder-coated aluminium. An annual cleaning using the **Renson Maintenance Set** products will ensure that the intense colour is maintained for years, as well as providing extra protection from acid rain, sea air, and UV rays. We recommend carrying out maintenance on your installations at least twice a year in coastal or wooded areas.
- The **Renson 'Clean'** is a concentrated product with strong cleaning and degreasing properties to deal with the most frequent kinds of natural filth, such as dust, oily precipitation, grease stains, moss, insect remains, etc. This product cannot be compared to other cleaning products on the market. It penetrates deeply and 'lifts out' the dirt. Renson 'Clean' can also be used to clean polyester roof fabrics and vertical fibreglass fabric screens. After cleaning, you must protect the aluminium structure using **Renson 'Protect'**. This leaves a protective film that allows the surface to be cleaned by simply wiping it down using a minimum amount of **Renson 'Clean'**. It also protects the aluminium from acid rain, sea air and UV rays, and ensures the colour remains just as intense.
- Do not use either product in direct sunlight or in hot weather. The product's quick-drying action can leave stains on the structure or the fabric screen. Do not use corrosive or aggressive products, scouring pads or other scouring products. Do not use high-pressure equipment in any case whatsoever.



Register your patio cover within 15 days of its installation and receive



WARRANTY

www.renson-outdoor.com/warranty



* The colour and gloss of the paint is guaranteed for 5 years. If you register the covering and annually clean and protect it with the Renson Maintenance Set, you get an extended paint guarantee of up to 15 years.

RENSON®: YOUR PARTNER IN VENTILATION, SUN PROTECTION, AND OUTDOOR CONCEPTS

Renson®, headquartered in Waregem (Belgium), is the European trendsetter in ventilation, sun protection, and the outdoors.

Creating healthy spaces

Based on experience dating back to 1909, we developed energy-efficient total solutions that strive to create a healthy and comfortable indoor and outdoor climate. Our strikingly designed head office is a beautiful example that reflects our corporate mission. It is built in accordance with the Healthy Building Concept.

No speed limit on innovation

A multidisciplinary team of more than 90 R&D employees continuously optimises our products and develops innovative total concepts.

AS THE END CUSTOMER, WHERE CAN YOU FIND RENSON® PRODUCTS?

To ensure high-quality expertise and professional installation of Renson® products, we have set up a network of well-trained Ambassadors and Installers.

Renson® Premium Ambassadors

These are ambassadors with years of experience selling and installing Renson® products. They stay updated on the whole range and guarantee the utmost professional assistance.

Renson® Ambassadors display our products in their showrooms and ensure that the product you have purchased is professionally and properly installed by their own installation team. In addition, they also guarantee professional after-sales service.

See also www.renson.eu



YOU CAN ALSO DOWNLOAD OUR OTHER INSPIRATION BROCHURES ON WWW.RENSON.EU



VENTILATION



SUN PROTECTION

RENOVATION/ (RE)BUILDING PLANS? VISIT OUR SHOWROOM

EXIT 5 is open
Monday to Friday: 8h30 – 12h00 and 13h30 – 18h00
Saturday: 9h00 – 12h00

Make an appointment by phone on 056 62 96 87 or online via www.exit5.be

Maalbeekstraat 10 - 8790 Waregem - België
www.exit5.be



Creating healthy spaces

RENSON® Headquarters
 Maalbeekstraat 10, IZ 2 Vijverdam B-8790 Waregem
 Tel. +32 (0)56 62 71 11
 info@renson.eu
 www.renson-outdoor.com

